

Cable carrier configuration



Brands of TSUBAKI KABELSCHLEPP GmbH are protected as national or international trademarks in the following countries:
kabelschlepp.de/trademarks

Subject to change.

Content

01

Cable carrier design page 46

- Solid plastic, hybrid and steel cable carriers
- Pitch and inner height as characteristic parameters for cable carriers
- Explanation of KR and RKR as well as KR/RKR

02

Stay variants page 51

- Overview
- Opening options
- Explanation of fully stayed and half-stayed

03

Divider systems page 56

- Overview
- Explanation of the systems TS0, TS1, TS2, TS3 and LG

04

Connection variants page 58

- Explanation of UMB, plastic end connectors and steel end connectors
- Connection variants

05

Strain relief elements page 60

- Overview and explanation of strain relief options

06

Gliding elements page 61

- Use of glide shoes

07

Multi-band cable carriers page 62

- Area of application for multi-band cable carriers

01 Cable carrier design

Key for abbreviations
on page 16

Design guidelines
from page 64

Technical support:
technik@kabelschlepp.de

online-engineer.de
Cable Carrier Configurator

1.1 Solid plastic, hybrid and steel cable carriers

Our product portfolio offers one of the largest modular systems for cable carrier systems within the industry with regard to material and type variants. Depending on the series and cable carrier type, the cable carriers have different designs.

Solid plastic cable carriers

TSUBAKI KABELSCHLEPP offers a great variety of different solid plastic cable carriers with predefined widths. All cable carriers combine robustness and reliability with an attractive price-performance ratio. Fast and easy installation of cables and hoses is another advantage of these cable carriers.

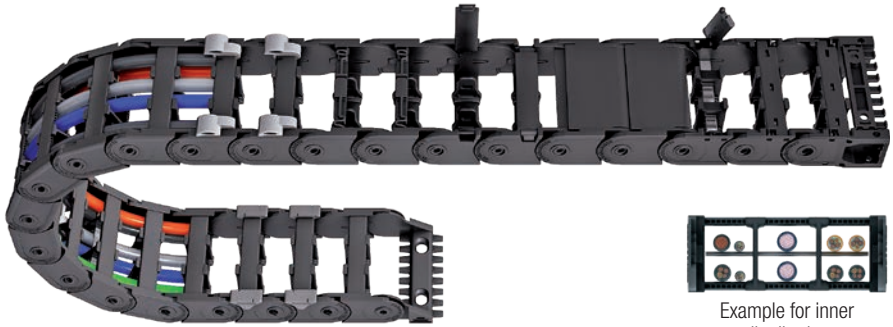

Hybrid cable carriers

Hybrid cable carriers from KABELSCHLEPP® offer a high level of variability for cable carrier widths and separation options within the cable carrier. This allows reliable and efficient partitioning even for complex cable configurations. Hoses and cables with larger diameters can also be accommodated and guided.

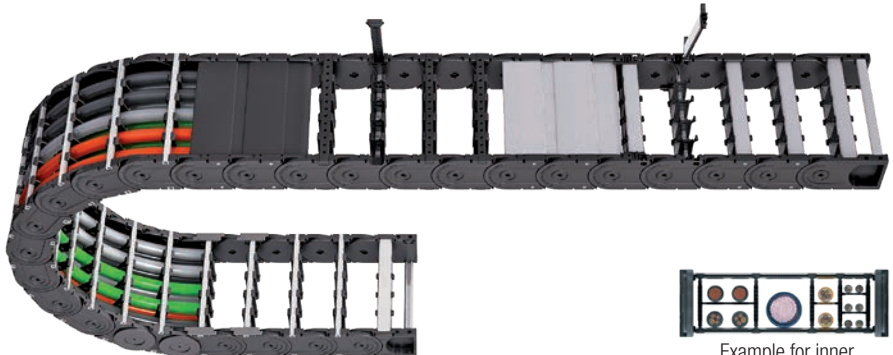

Steel cable carriers

Special applications require the use of special cable carriers. Our steel and stainless steel cable carriers are ideal for extreme heat or other extremely rough ambient conditions, such as in mining, in the steel industry or in the oil industry. Standardized separating options offer best possible protection for cables and hoses even under strong mechanical strain.

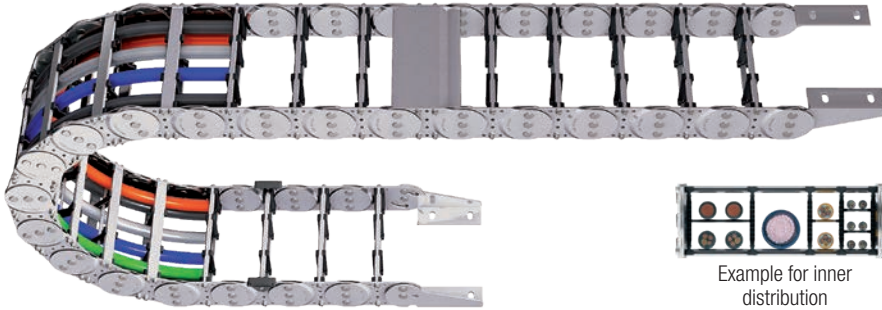

Cable carriers consisting of side bands

Band carriers consist of two parallel side bands which are connected with different stay and cover variants. These cable carrier types made of plastic, aluminum or steel offer more variability compared to one-part versions, even for large widths – depending on the stay variant even in a 1 mm grid and more separation options within the cable space.

This allows reliable and efficient partitioning even for complex cable configurations, including with individual hole stays. Hoses and cables with large diameters can also be accommodated and guided without problems. Closed systems provide even better protection.

One-part cable carriers

On one-part cable-carriers, the body section consists of a single component. Crossbars, lamella or covers are mounted on the cable carrier body separately or manufactured directly together with the chain link.

Our basic range comprises a variety of different product types with predefined cable carrier widths. All cable carriers combine robustness and reliability with an attractive price-performance ratio. Fast and easy installation of cables and hoses is another advantage of these cable carriers. Covered and completely enclosed product types ensure optimum protection of the cables and hoses against chips and other coarse contamination.

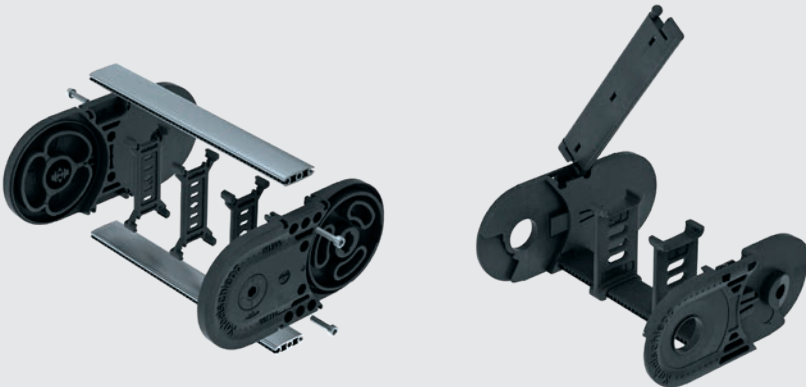

BASIC-LINE

Solid plastic cable carriers
with fixed widths



- Cost-effective solutions for standard applications
- Types and designs with fixed or opening crossbars
- Numerous types and designs available from stock immediately
- Fast cable laying
- Ideal for short travel lengths and high travel speeds
- Types for long travel lengths available

BASIC-LINE^{PLUS}

Solid plastic cable carriers
with fixed widths



- Cost-effective solutions for standard applications
- Easy pulling/pressing of the cables into the cable carrier
- Very fast cable laying
- Numerous types and designs available from stock immediately
- Ideal for short travel lengths and high travel speeds

3D-LINE

Cable carriers
for 3D applications



- Ideal for maximum freedom of movement in 3D applications
- Three-dimensional swivel and rotation movements, for example on robots for use from robot base to robot wrist
- Extend the service life of cables in 3D applications through defined minimum bending radius and separation and guiding of the cables
- For extremely high tensile forces and accelerations

STEEL-LINE

Steel cable carriers
for extreme applications



- Robust design for high mechanical loads
- High additional loads and extensive unsupported lengths possible
- Ideal for extreme and rough environmental conditions
- Heat-resistant

Cable carrier configuration | Cable carrier design

VARIO-LINE

Cable carriers with variable chain widths



- Aluminum stays available in 1 mm width sections
- Plastic stays available in 4, 8 or 16 mm width sections (depending on type)
- Easy and quick to open inside and outside
- Light, extremely robust or linkless series
- Cable carriers for complex applications

TUBES-PLASTIC

Covered solid plastic and hybrid cable carriers



- Covered cable carriers with plastic or aluminum cover systems
- Aluminum cover systems in 1 mm width sections
- To protect cables and hoses against chips or dirt
- Easy and quick to open inside and outside

TUBES-STEEL

Covered steel cable carriers for extreme applications



- Robust design for high mechanical loads
- High additional loads and extensive unsupported lengths possible
- Ideal for extreme and rough environmental conditions
- Heat-resistant

ACCESSORIES

for cable carriers



Our extensive range of accessories for a variety of different applications turn cable carriers into complete cable carrier systems. In addition to chutes and channels, support elements and guiding elements, we offer application-specific products such as driver connections or opening tools.

1.2 Pitch and inner height as characteristic parameters for cable carriers

Pitch and inner height are essential components of application-specific solutions. Depending on the installation space of your application, these have to be configured individually. The chapter "Cable carriers" from page 14 offers an overview of the configuration options, depending on the cable carrier type.

Key for abbreviations
on page 16

1.3 Explanation of KR and RKR as well as KR/RKR

A cable carrier can be deflected at a defined bending radius (KR). A reverse bending radius (RKR) is the formation of a radius (preferably on the driver of a cable carrier) in the opposite direction to the actual KR of the remaining cable carrier. This variant is used, for example, for reducing the cable carrier overhand in the thrust end position (station length).

This version is used for gliding cable carriers with long travel lengths, among other applications. Depending on the cable carrier type, we offer standardized models with so-called GO modules. The cable carrier can also be deflected in both swivel directions (KR/RKR), e.g. for circular arrangements.

Design guidelines
from page 64

KR (bending radius)

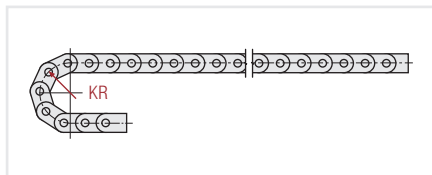

RKR (reverse bending radius)

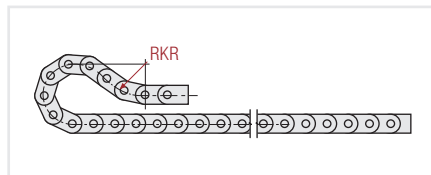

GO module

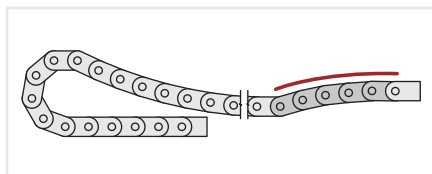

Pull position

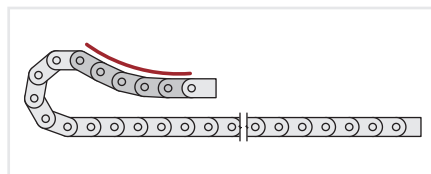

Push position

Technical support:
technik@kabelschlepp.de

online-engineer.de
Cable Carrier Configurator



TSUBAKI KABELSCHLEPP technical support

If you have any questions about the configuration of cable carriers or technical details, please contact our technical support service at technik@kabelschlepp.de. We will be happy to help you.

02 Stay variants

2.1 Overview

The stay variants available for each cable carrier series can be found in the overview of the associated catalog chapter or in the “Cable carriers” chapter from page 14.



Aluminum stay RS | Hybrid cable carriers

Narrow frame stay “The standard”

- Extremely quick to open and close
- Aluminum profile bars for light to medium loads. Assembly without screws.
- Available customized in **1 mm grid**.
- **Inside/outside:** release by turning by 90°.



Aluminum stay RS 1 | Steel cable carriers

Narrow frame stay “The standard”

- Extremely quick to open and close
- Aluminum profile bars for light to medium loads. Assembly with screws.
- Available customized in **1 mm grid**.
- **Outside:** release by turning by 90°.
- **Inside:** threaded joint easy to release.



Aluminum stay RS 2 | Steel cable carriers

Frame stay narrow, bolted

- Quick to open and close.
- Aluminum profile bars for light to medium loads. Assembly with screws.
- Available customized in **1 mm grid**.
- **Inside/outside:** threaded joint easy to release.



Aluminum stay RV | Hybrid cable carriers

Frame stay, reinforced

- Aluminum profile bars with plastic adapter for medium to high loads and large cable carrier widths. Assembly without screws.
- Available customized in **1 mm grid**.
- **Outside/inside:** release by turning by 90°.

Cable carrier configuration | Stay variants

**Aluminum stay RV** | Steel cable carriers**Frame stay, reinforced**

- Aluminum profile bars with plastic adapter for medium to high loads and large cable carrier widths. Double threaded joint on both sides.
- Available customized in **1 mm grid**.
- **Inside/outside:** Threaded joint easy to release.

**Aluminum stay RM****Frame stay, solid**

- Aluminum profile bars for heavy loads and maximum cable carrier widths. Double threaded joint on both sides "**Heavy Duty**".
- Available customized in **1 mm grid**.
- **Inside/outside:** threaded joint easy to release.

**Aluminum stay LG****Hole stay, split version**

- Optimum cable routing in the neutral bending line. Split version for easy cable routing. Stays also available unsplit (aluminum stay LU).
- Available customized in **1 mm grid**.
- **Inside/outside:** threaded joint easy to release.

**Aluminum stay RMF****Frame stay, solid with optional fixing bar**

- Aluminum profile bars for heavy loads and large cable carrier widths. Simple threaded joint.
- Available customized in **1 mm grid**.
- **Inside/outside:** threaded joint easy to release.

**Aluminum stay RMS****Frame stay solid with ball joint**

- Aluminum profile bars with plastic fixing ball joint. Assembly without screws.
- Opening and detachable on both sides in any position.
- Available customized in **1 mm grid**.
- **Inside/outside:** Opening and detachable.

Cable carrier configuration | Stay variants



Aluminum stay RMA

Mounting frame stay

- Aluminum profile bars with plastic mounting frame stays for guiding very large cable diameters.
- Available customized in **1 mm grid**.
- **Inside/outside:** threaded joint easy to release.



Aluminum stay RMR

Frame rolling stay

- Aluminum profile bars with rotating plastic rolling stay for highest requirements with gentle cable guiding. Double threaded joint on both sides.
- Available customized in **1 mm grid**.
- **Inside/outside:** threaded joint easy to release.



Steel stay RR

Frame stay, tube version

- Steel rolling stays with gentle cable support and plastic dividers. With plastic or steel dividers, depending on cable carrier type. Ideal for using media hoses with soft jackets. Simple threaded joint.
- Available customized in **1 mm grid**.
- **Inside/outside:** Threaded joint detachable.



Aluminum stay RSH

Frame screw-in stay

- Aluminum profile bars for light and medium loads. Assembly without screws.
- Available customized in **1 mm grid**.
- **Outside/inside:** release by turning.



Aluminum cover RMD | Hybrid cable carriers

Cover with hinge in the outer radius “standard”

- Aluminum cover system with hinge for light and medium loads. Assembly without screws.
- Available customized in **1 mm grid**.
- **Outside:** swivable to both sides.
- **Inside:** release by turning by 90°.

Cable carrier configuration | Stay variants

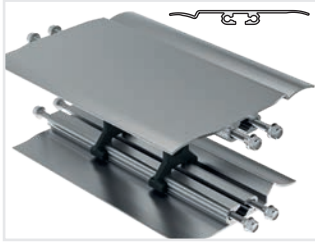

Aluminum cover RMD | Steel cable carriers

Aluminum cover system

- Bolted aluminum covers for maximum stability.
- For applications generating chips or coarse contamination.
- Available customized in **1 mm grid**.
- **Inside/outside:** threaded joint easy to release.



Plastic stay RE

Frame screw-in stay

- Plastic profile bars for light and medium loads. Assembly without screws.
- Available customized in **4, 8 or 16 mm grid** depending on type.
- **Outside/inside:** release by turning by 90°.



Plastic stay RE

Frame screw-in stay

- Plastic profile bars for light and medium loads. Assembly without screws.
- Available in fixed widths depending on type.
- **Outside/inside:** release by turning by 90°.

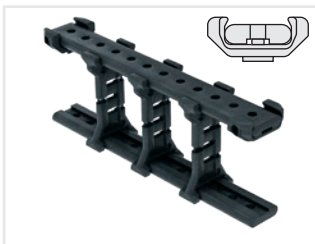

Plastic stay RD

Frame stay with hinge

- Plastic profile bars with hinge for light and medium loads. Assembly without screws.
- Available customized in **8 or 16 mm grid** depending on type.
- **Outside:** swivable to both sides.
- **Inside:** release by turning by 90°.



Plastic cover RD

Cover with hinge in the outer radius "standard"

- Plastic cover system with hinge for light and medium loads. Assembly without screws.
- Available customized in **8 or 16 mm grid** depending on type.
- **Outside:** swivable to both sides.
- **Inside:** release by turning by 90°.

Cable carrier configuration | Stay variants

2.2 Opening options

The stays in the cable carriers can be opened in different ways, depending on the stay variant. Detailed information can be found in the overview of the stay variants from page 45 and in the respective catalog chapters for the cable carrier types.

Overview of opening principles

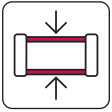

Cannot be opened



Opens outside

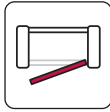

Opens inside

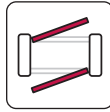

Opens inward/
outside

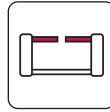

Opening slot
outside

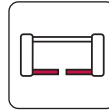

Opening slot
inside

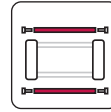

Bolted inside/
outside

2.3 Explanation of fully stayed and half-stayed

Depending on the version, a different number of stays can be mounted on the number of chain links in our cable carriers. Essentially, there are two versions:

Half-stayed (HS)



Most cable carriers are supplied half-stayed as a standard (stay of every 2nd link). This excludes closed cable carriers where no half-stayed version is available and versions where chain link and stay form a unit.

The half-stayed cable carrier versions still offer a very high level of stability thanks to a sturdy connection between the stays and the link plates. In addition to the cost advantage due to fewer components, this also results in reduced assembly time.

As the dividers are also mounted on every 2nd chain link

Fully-stayed (VS)



as a standard, the same structure for the inner distribution as in a fully-stayed cable carrier can be used on a half-stayed version. After examination of the application at hand, we may recommend using fully-stayed cable carriers when installing very thin cables or when using very narrow cable carriers to improve side stability.

03 Divider systems

3.1 Overview

Divider and height separation serve to separate cables in the cable carrier cross section. These can be arranged evenly next to each other, on top of each other and offset.

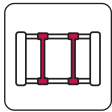

TS0

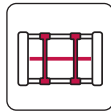

TS1

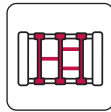

TS2

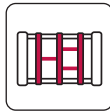

TS3

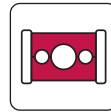

Hole stay

As a standard, the divider system is mounted at every 2nd chain link.

3.2 Explanation of the systems

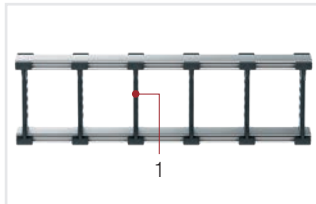

Divider system TS0 without height separation

Dividers for vertical separation [1] can be installed between all types of stay variants. The efficiently separate the cables to prevent friction between different jacket materials. This provides best possible protection for cables and insulation.

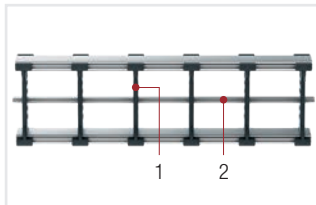

Divider system TS1 with continuous height separation

In addition to the vertical separation with dividers [1], the inner height is divided into several levels with a horizontal height separation [2] across the entire inner width, systematically layer by layer. This creates order and a clear structure for multiple cables with a similar cross section.

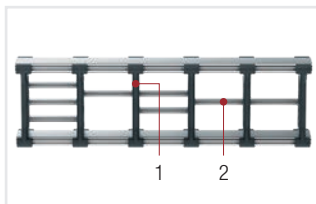

Divider system TS2 with partial height separation

This divider system allows all combinations of vertical separation with dividers [1] and partial horizontal height separation [2] made of aluminum in a 1 mm grid.

Cable carrier configuration | Divider systems

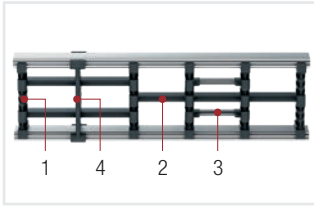

Divider system TS3

with height separation made of plastic partitions

This divider system allows all combinations of vertical separation with dividers [1] and partial horizontal partitions made of plastic [2] or optionally of aluminum [3] in a 3 mm grid. These can also be retrofitted or changed by rearranging.

The twin divider [4] additionally provides the option of subsequent vertical separation.

Modern TS3 divider systems (MASTER series) reduce the packaging space required for this to a minimum, providing more cable space.

Width comparison

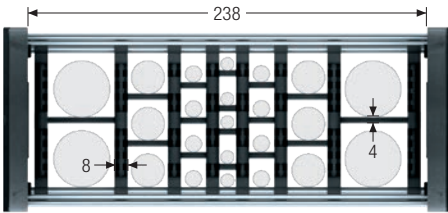

Previous divider system TS3 with stay variant RSH/RE

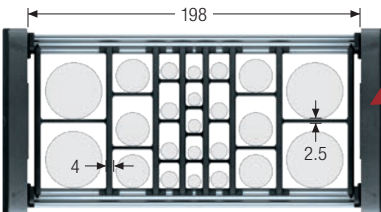

40 mm less inner width required!

Significant space saving with same filling capacity through the new divider system TS3 with stay variant RSH/RE

Width optimization through adapted dividers

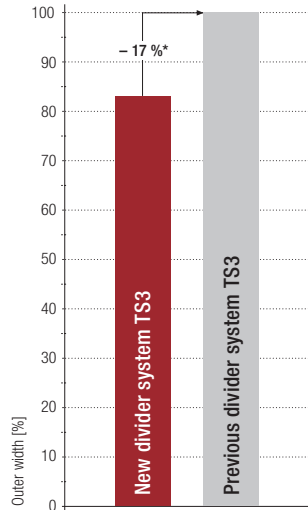

* For inner width $B_i = 238$ mm with stay variant RE



Cable routing with hole stays

Stay variant LG

Individually manufactured hole stays allow the inner distribution to be ideally adapted to your cables. The hole stays can be guided in the neutral bending line. Cable carriers with aluminum stays can therefore be ordered customized to the millimeter.

The hole stay system is also very easy to assemble because the cable openings are freely accessible by removing the top part.

04 Connection variants

4.1 Explanation of UMB, plastic end connectors and steel end connectors

Depending on the cable carrier type and specific application, we offer different end connectors for fastening your cable carrier to your plant sections.

- **Driver connection:** Fastening to moving machine or plant parts.
- **Fixed point connection:** Fastening to static machine or plant parts or the floor.

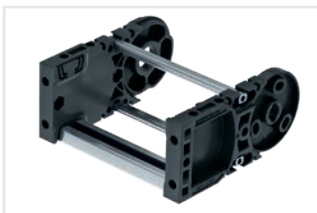

Universal end connectors (UMB), plastic

The universal end connectors (UMB) can be connected from the top, from below at the face side or – depending on the type – at the side. An accommodation for strain relief with C-rails and LineFix clamps or strain relief combs is integrated. Universal end connectors are made of solid plastic without metal bushes.



One-part end connectors, plastic

One-part end connectors made of solid plastic can be arranged on the cable carrier in different variants depending on the customer fastening. They are optionally available with integrated strain relief.



Multi-part end connectors, plastic/steel

Link section made of solid plastic, steel end connector. The multi-part end connectors can be connected from the top, from underneath or at the face side, depending on the type. Depending on the cable carrier type, strain reliefs with separate C-rail or strain relief comb can be integrated.



Multi-part end connectors, steel

End connectors made of steel. The multi-part end connectors can be connected from the top or from underneath, depending on the type. Depending on the cable carrier type, strain reliefs with separate C-rail can be integrated.

Cable carrier configuration | Connection variants

4.2 Connection variants

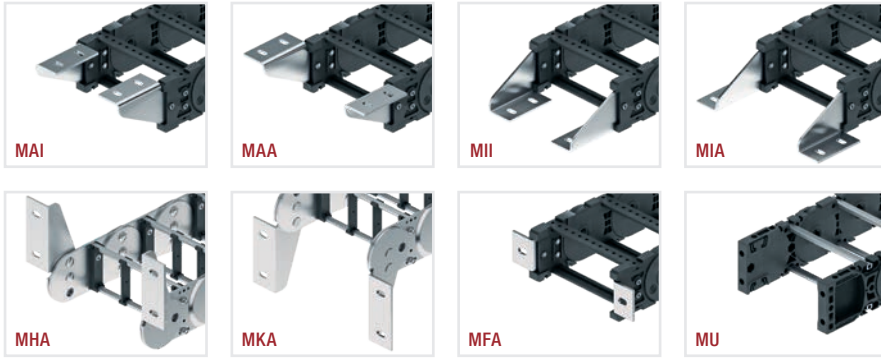
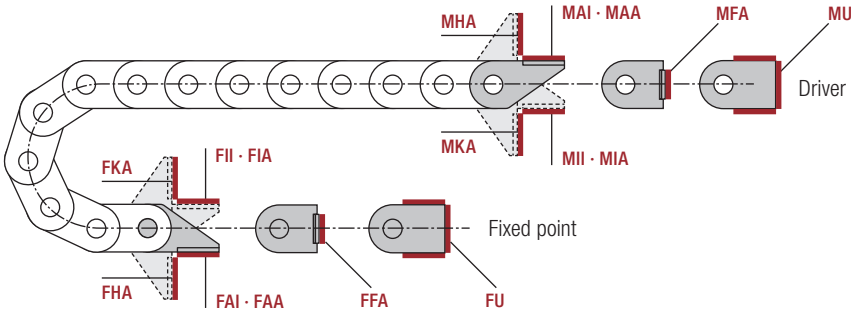

Connection point

- F – fixed point
- M – driver

Connection type

- A – threaded joint outside (standard)
- I – threaded joint inside
- H – threaded joint, rotated 90° to the outside
- K – threaded joint, rotated 90° to the inside
- F – flange connection

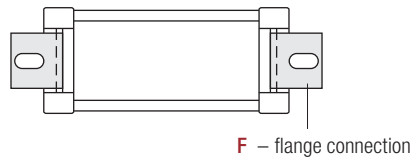

Connection surface

- I – connection surface inside
- A – connection surface outside

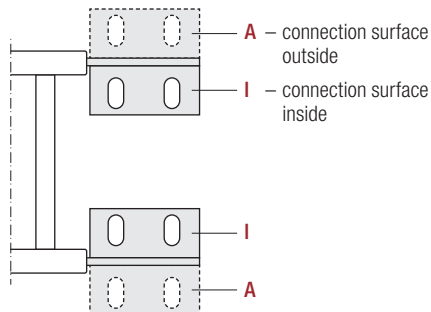

Subject to change.

As a standard, the end connectors are installed with the threaded joint (connection type) to the outside and the connection surface to the inside (FAI/MAI).

05 Strain relief elements

5.1 Overview and explanation of strain relief options

The strain relief for the cables depends on cable type, length of the cable carrier and installation position. Depending on the cable carrier type and specific application, we offer different strain relief options.



LineFix® clamps

These clamps can be positioned next to each other with a C-rail. The C-rail is integrated into the end connector or has to be fastened separately in front of it.

Detailed information can be found in chapter *Accessories* from page 716.



Strain relief combs

Strain relief combs can be used to connect the cables to the existing teeth with cable ties. The strain relief combs are integrated into the end connector or have to be fastened separately in front of it.

Detailed information can be found in chapter *Accessories* from page 718.



SZL strain reliefs

The SZL strain reliefs hold the cables with half shells and fix them in position with detachable clamps. The C-rail is integrated into the end connector or has to be fastened separately in front of it.

Detailed information can be found in chapter *Accessories* from page 720.



Block clamps

Block clamps are usually used for hoses and hold these with two half shells bolted together, which can be attached to a C-rail. The C-rail is integrated into the end connector or has to be fastened separately in front of it.

Detailed information can be found in chapter *Accessories* from page 721.

More on the use of strain reliefs and assembly information can be found in the *configuration guidelines* from page 48.

06 Gliding elements

6.1 Use of glide shoes

We offer different solutions for a substantially extended service life of the cable carrier in case of long travel lengths in gliding operation.



Replaceable glide shoes made of plastic

The replaceable glide shoes are a very cost-efficient solution as only the glide shoes and not the complete cable carrier have to be replaced when worn. An abrasion resistant material is used for travel speeds > 2.5 m/s and high additional loads.

OFFROAD glide shoes with 80% greater wearing volume is also available for the types M0650-M1300. We recommend their use for extreme ambient conditions (for especially abrasive substances such as sand, dust, corundum).



Slide discs

If the cable carrier is positioned so it is rotated by 90° (gliding on the outside of the side band), slide discs snapped onto the side optimize the friction and wear situation.

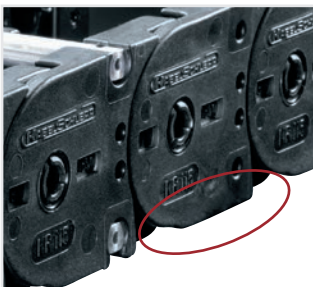

Molded slide runners

These ensure a long service life of the cable carrier for long travel lengths and high additional loads.

07 Multi-band cable carriers

Key for abbreviations
on page 16

Design guidelines
from page 64

Technical support:
technik@kabelschlepp.de

online-engineer.de
Cable Carrier Configurator

7.1 Area of application for multi-band cable carriers

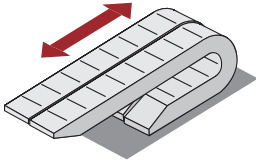

High additional loads and longest possible service lives are a challenging combination for the design engineering of cable carriers. Many applications are subject to extreme ambient conditions, requiring special solutions. If the max. permitted width or load for the cable carrier are exceeded, multi-band cable carriers are used where additional side bands are installed between the two outer side bands.

Cable carriers in multi-band design made from plastic or steel can manage significantly higher loads compared to the conventional version. The use of aluminum frame stays allows implementation of precision-fit cable carrier widths with high stability. The most common structures are three-band and four-band cable carriers.



The cable-carriers with double-band design are designed for a particularly long service life, such as the types LS/LSX1050 and MC1300. In this design, an additional side band is bolted to the existing one.

This results in maximum stability, allowing the double-band cable carrier to double its load capacity.

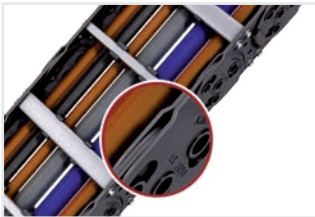



change

Cable carrier
configuration

tsubaki-kabelschlepp.com

Configuration guidelines

Selecting a suitable cable carrier

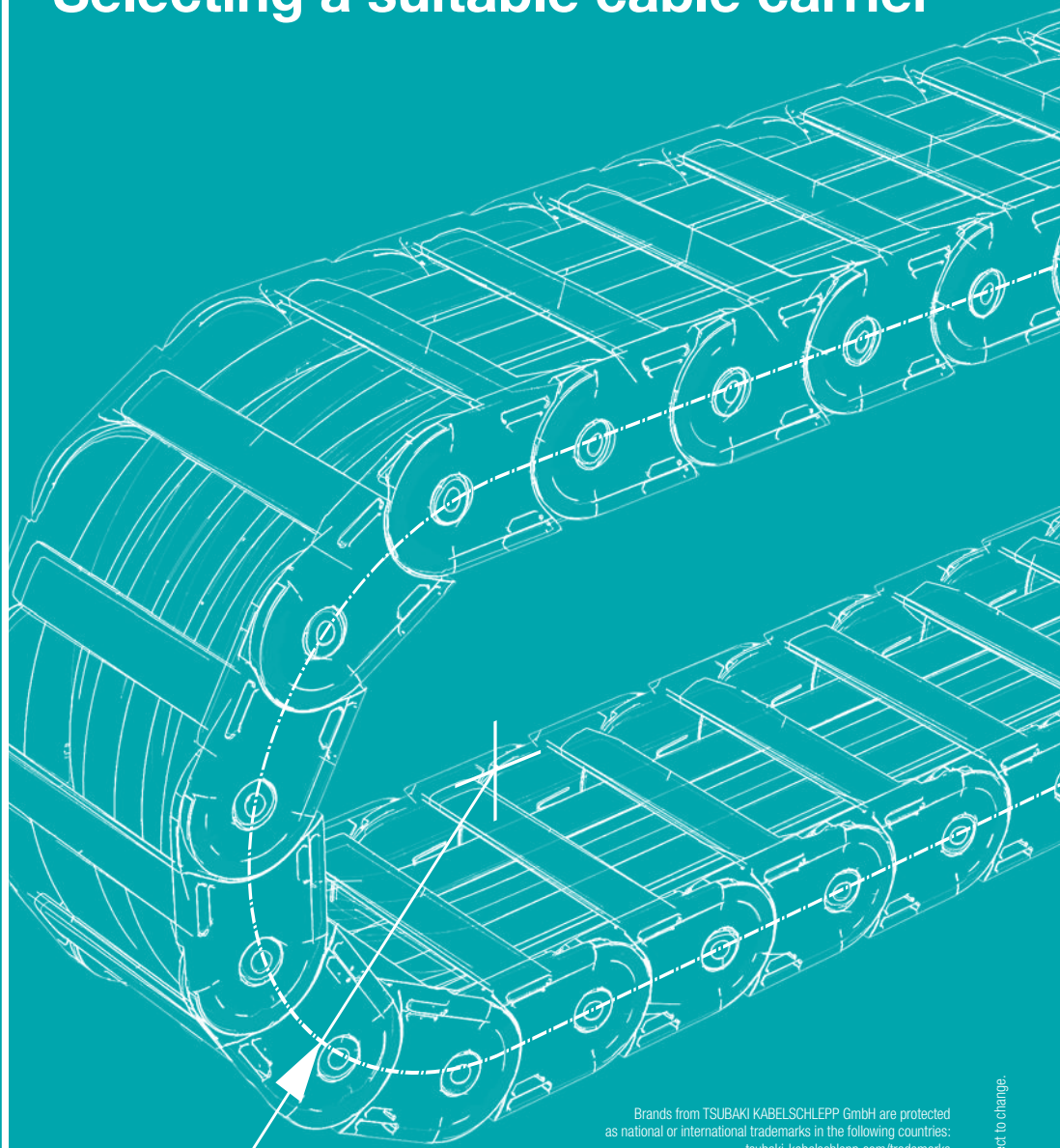

Brands from TSUBAKI KABELSCHLEPP GmbH are protected as national or international trademarks in the following countries: tsubaki-kabelschlepp.com/trademarks

Subject to change.

Content

01

Selecting a suitable cable carrier page 66

- Required basic data for determination
- Selecting the suitable version
- Defining the cable carrier size
- Determining the cable carrier length (L_k)
- Connection height, pretension & installation height
- Consideration of stability
- Consideration of relative displacement

02

Placement guidelines for cables and hoses page 74

- General guidelines
- Placement of pressure hoses
- Strain relief
- Strain relief for gliding cable carriers

03

Installation variants page 78

- Examples for your application

01 Selecting a suitable cable carrier

Key for abbreviations on page 16

Design guidelines from page 64

Technical support: technik@kabelschlepp.de

online-engineer.de
Cable Carrier Configurator

1.1 Required basic data for determination

The cable carrier is selected based on different factors which have to be considered in combination. The following parameters should therefore be already available when starting to select a cable carrier:

- **Installation of cables and hoses**
(Number and diameters of the installed cables and hoses as well as the cable weight including media (kg/m), required minimum bending radius)
- **Dynamic parameters**
(Travel speed, acceleration/deceleration, desired motion cycles)
- **Motion sequence**
(For which type of motion is the cable carrier used?)
- **Installation situation**
(How much space is available? Installation width? Installation height?)
- **Operating temperature**
- **Contamination and degree of contamination**
(Which type of contamination? Which amount?)
- **Application-specific ambient influences**
(e.g. chips, oil, moisture, chemicals)

1.2 Selecting a suitable version

TSUBAKI Kabelschlepp offers a variety of cable carriers for all areas of application. The suitable product can be roughly determined with the available basic data.

Selecting the suitable material: side bands made of steel or plastic?

In addition to the environmental conditions, the selection of the suitable material is determined by the dynamic parameters and the load on the cable carrier. Plastic cable carriers have become established in many areas of application over the years. The application should always be examined in detail beforehand, though. The following table shows the operating parameters as a configuration tool for the suitable cable carrier material:

Operating conditions	Plastic	Steel	Operating conditions	Plastic	Steel
Travel speed > 2 m/s	+	-*	Vacuum	-	+***
Travel cycle > 1 million	+	-*	Extremely rough operating conditions (e.g. heavy industry, mining, drilling)	•	+
Continuous temperature < -40° C	-**	+	Very high mechanical load	•	+
-40° C to +100° C	+	+			
> +100° C	-**	+			
Acidic environment	-	+***	+ very suitable	* possible as custom version	
Radioactive radiation	-	+***	• suitable	** special material available	
			- not suitable	*** stainless steel version available	

Our technical support can provide help for critical applications: technik@kabelschlepp.de

Configuration guidelines | Selecting the cable carrier

Selecting the cable protection: open or closed cable carrier?

The selection of the suitable cable carriers can be further limited with the question whether the guided cables require additional protection (e.g. against foreign bodies) and whether a cable carrier with a cover system is practical.

The following table is a simple guideline; the exact choice should be determined after detailed examination of the specific application. In many cases, closed cable carriers are also used to hide the cables for visual reasons.

For very large accumulations of fine contamination (e.g. dust or sand), especially in combination with moisture, we advise against using the cover systems. This affects the function of the overlapping covers substantially.

Cover systems are available for steel and plastic cable carriers.

Operating conditions	Open cable carriers	Covered cable carriers
Coarse contamination (e.g. chips, metal parts, glass splinters)	•	+
Hot chips/metal spatter	–	+*
Visual protection (hiding the cables)	–	+
Very high incidence of fine contamination (e.g. sand, dust, scale)	•/+	–
Very fine contamination and moisture (e.g. moist dust)	•/+	–

- + very suitable
 - suitable
 - not suitable
- * Also possible as steel band cover, see page 846
Special materials for covers on plastic cable carriers possible

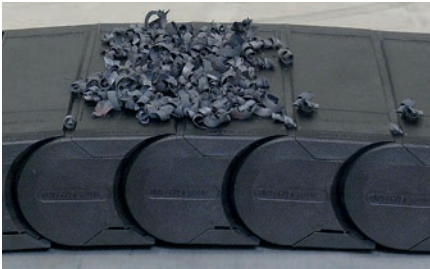

Example:
Cover system with chips



Negative example:
Cover system with high dust accumulation

According to the specification plastic/steel and open/closed, you can select the suitable cable carriers according to the following diagram in the respective catalog chapter:

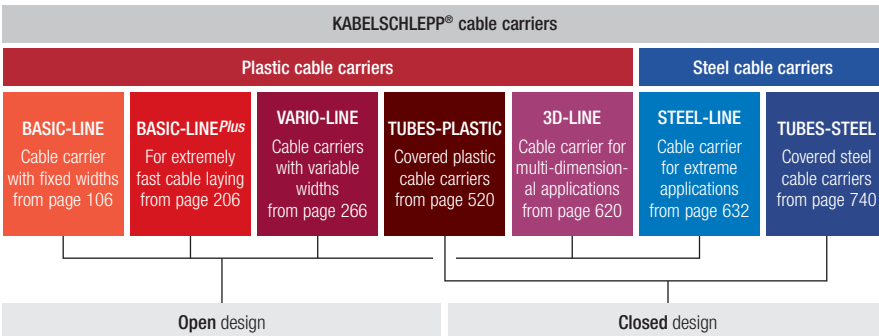

1.3 Defining the cable carrier size

The number and diameter of the cables to be installed play a major role here. Very often, the dimensions of the installation space for using a cable carrier are very limited. Both these prerequisites therefore have to be balanced.

The basic data of the cables to be installed are required for the further configuration of the cable carrier:

- Type (cable or hose)
- Cable weight incl. media (q_z)
- Outer diameter (d)
- Minimum bending radius (KR_{min})

Please select a cable carrier with a sufficient inner height (see page 42). Adequate space on the side for placing the cables should also be planned for the initial configuration. They have to be arranged freely in the cross section of the cable carrier. The following minimum values for the required space apply:

Cables: $1.1 \times d$ (for diameter $d < 20$ mm, minimum required space: $d + 2$ mm)

Hoses: $1.2 \times d$ (for diameter $d < 20$ mm, minimum required space: $d + 4$ mm)

More information for installing cables can be found in chapter *Placement guidelines* on page 74.

The first draft for a so-called stay pattern can then look as follows, for example:

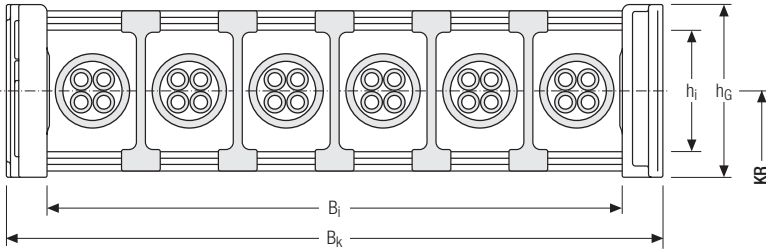

It is possible that the cable carrier becomes too wide with regard to the permitted installation dimension. In this case, a larger cable carrier can be used in combination with one of the divider systems. The placement could then look as follows, for example:

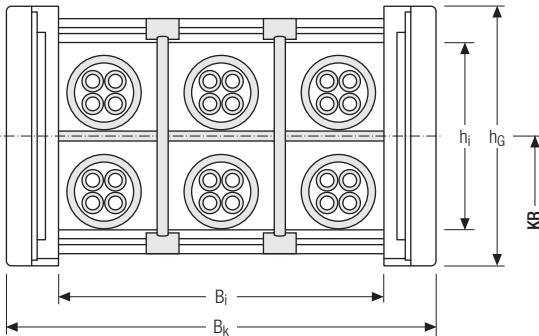

For the installation of cables in the cable carrier, please also take the selected installation variant into account (see page 78) which can have additional implications for loading the cable carrier. The different available stay variants (e.g. hole stay, tube stay) also allow different variations to suit the application.

This initial draft still has to be verified with regard to the further configuration of the cable carrier in the following (e.g. unsupported use).

Determining the bending radius KR

The chapter for the selected cable carrier contains the sizes of the available bending radii. The selection of the bending radii depends on the cables used. The information from the cable manufacturer regarding the dynamically moving minimum bending radius have to be taken into account for this.

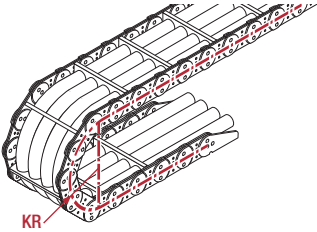

The selected bending radius of the cable carrier has to be equal to or greater than the largest minimum bending radius of the cables to be installed.

We recommend using KABELSCHLEPP® cables which were specially designed for use in cable carriers.

1.4 Determining the cable carrier length L_k for simple linear travel

It is practical to place the fixed point connection at the center of the travel path. This provides the shortest connection between fixed and movable driver point and therefore the most economical cable carrier and cable length. Of course your cable carrier can also be installed with a fixed point outside of the center of the travel path. The calculation follows these examples:

For **fixed point at the center** of travel path L_s , the following applies for cable carrier length L_k :

Cable carrier length L_k

$$L_k \approx \frac{L_s}{2} + L_B$$

Cable carrier length L_k rounded to pitch t

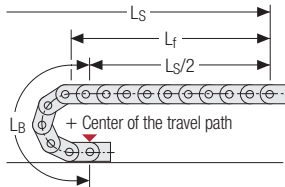

The length of carrier in bend L_B is determined according to the selected cable carrier type:

Type	Length of carrier in bend L_B
Plastic cable carriers	$L_B = KR \times \pi + 2 \times t$
LS/LSX series	$L_B = KR \times \pi + 2 \times t$
S/SX series	$L_B = KR \times \pi + 4 \times t$
QUANTUM® series	$L_B = KR \times \pi + 12 \times t$
TKR series	$L_B = KR \times \pi + 2 \dots 4 \times t$

The calculated values can be found in the tables in the respective individual chapters.

For **fixed point outside of the center** of travel path L_s , the following applies for cable carrier length L_k :

Cable carrier length L_k

$$L_k \approx \frac{L_s}{2} + L_B + |L_V|$$

Cable carrier length L_k rounded to pitch t

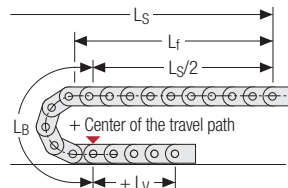
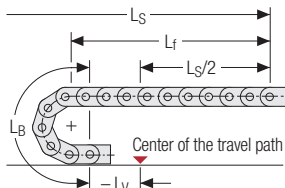

Verification of the load values for unsupported arrangement

The term "unsupported arrangement" describes the condition when the upper run moves parallel to the lower run across the entire horizontal travel length.

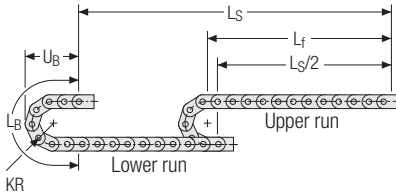

The unsupported arrangement is the most common use of cable carriers. The unsupported length L_f resulting from the travel length, and its load on the cable carrier is determined with the cable weight to be guided q_z from the load diagram.

The load diagram therefore marks the area of the unsupported length L_f in which the cable carrier has no appreciable sagging or, in reverse conclusion, the maximum cable weight at which the cable carrier does not yet sag. If the travel length or the cable weight increases above the value stated in the diagram, the cable carrier starts to sag.

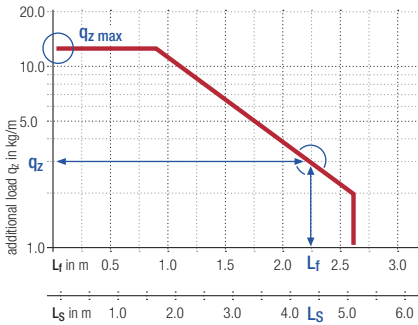

The specific load diagrams can be found in the individual chapters. Please note that the diagrams were determined with a specific intrinsic cable carrier weight. This means that the usable additional load can be reduced for large cable carrier widths or for cover systems.

Furthermore, the upper value q_z in the diagram indicates the maximum additional load of the cable carrier.

This value must not be exceeded.

The figure on the left shows an example for a load diagram with the most important parameters for determining the respective cable carrier load.



According to definition, the unsupported length L_f is the length at which the upper run of the cable carrier has no appreciable sag.

For steel cable carriers, sagging is not permitted as a rule. The higher flexibility of the plastic cable carriers allow a slight increase of the additional load or of the unsupported length. As a rule, we advise against this *unsupported arrangement with permitted sag* L_p for reasons of dynamics and appearance.

Increased wear of the links also has to be expected. It cannot be ruled out, however, that in individual cases a solution may have to be implemented in this way at low travel speeds. In this case, please request the corresponding values from us.

We will be happy to advise you.

Key for abbreviations on page 16

Design guidelines from page 64

Technical support: technik@kabelschlepp.de

online-engineer.de
Cable Carrier Configurator

Exceeded the load diagram?

There are several options if the unsupported length of the cable carrier is exceeded:

- Selecting a more sturdy cable carrier with a longer unsupported length and higher additional load
- Using a multi-band carrier for increasing the additional load
- Supporting the upper run after the fixed point: depending on the dynamic parameters, this arrangement can practically double the travel length. We are happy to help with configuring a suitable support structure.
- For very long travel lengths, the cable carrier has to be configured as gliding or rolling.

More information on these installation variants can be found from page 78.

The overall length of the cable carrier

The cable carrier length L_K does not include the length l_1 of the end connectors. To be able to determine the correct required cable and hose length, the value L_{EF} is required. This is calculated as follows:

Overall length cable carrier L_{EF}

$$L_{EF} = L_K + l_1 \text{ Driver connection} + l_1 \text{ Fixed point connector}$$

1.5 Connection height, pretension & installation height

Kabelschlepp cable carriers are manufactured with pretension as a standard in order to implement the most extensive unsupported length possible. This produces an elevation of the upper run in the area of the unsupported length and is already considered in the load diagram.

The pretension increases the installation height of the cable carrier to the total value H_z . The connection height H and the installation height H_z are determined for each cable carrier type according to the following guidelines.

Connection height H and installation height H_z for plastic cable carriers

The values for determining the connection height H can be found in the respective individual chapters. They are generally determined as follows:

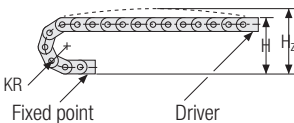

Installation height H_z is also listed in the respective individual chapters as an allowance for the pretension, specifically for each cable carrier.

Type	Connection height H
Plastic cable carriers*	$H = 2 KR + h_G$
M1300 series	$H = 2 KR + 1.5 h_G$
TKHD90 series	$H = 2 KR + 1.5 h_G$
QUANTUM® series	$H \approx 2 KR + \frac{4}{3} h_G$
TKR0150 series	$H = 2 KR + 40 \text{ mm}$
TKR0200 series	$H = 2 KR + 72 \text{ mm}$
TKR0370 series	$H = 2 KR + 70 \text{ mm}$
TKR0260 series	$H = 2 KR + 88 \text{ mm}$
TKR0280 series	$H = 2 KR + 102 \text{ mm}$

* not for M1300/TKHD90

Installation height H_z for steel cable carriers

Due to the higher stability of steel cable carriers, the pretension z can already be taken into account on unsupported arrangements by slightly increasing the connection height H . This is based on the following calculation:

Connection height H for systems *without support (unsupported)*

$$H = 2 KR + 1.5 h_G$$

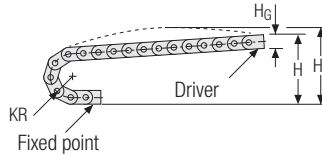

If the unsupported length is increased with support rollers or a continuous support frame, the upper run has to be placed parallel to the support plane.

Connection height H for systems *with support*

$$H = 2 KR + h_G$$

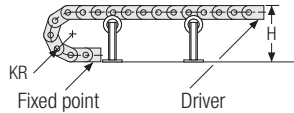

To be sure, another verification of the installation height H_z should be carried out for steel cable carriers depending on the pretension and cable carrier length. The following rule of thumb applies:

Installation height H_z

$$H_z = H + z$$

Pretension
 $z \approx 10 \text{ mm/m cable carrier length}$

For example, the installation height H_z for a cable carrier length of $L_k = 5000 \text{ mm}$ increases by 50 mm . Depending on the installation variant, it is still necessary to operate the cable carrier without or with reduced pretension. This is possible on almost all types.

1.6 Consideration of stability

In the tension end position, the stability of the cable carrier must be considered. For extensive unsupported lengths, the remaining small support area at the fixed point can reduce the stability for very narrow cable carriers. Accordingly, the ratio between bending radius KR and outer cable carrier width B_k should always be taken into account for dimensioning of the cable carrier.

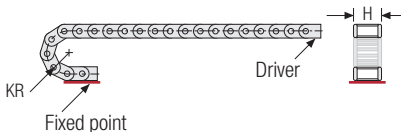

— Support area

If the outer cable carrier width on an extensive unsupported length is significantly smaller than the required bending radius, the option of a lateral support should be considered if stability seems at risk. In this case, please contact our technical support.

Configuration guidelines | Selecting the cable carrier

1.7 Consideration of relative displacement

An arrangement where the cables are placed next to each other and separately should be preferred. This arrangement is recommended to keep the relative displacement of the cables as low as possible.

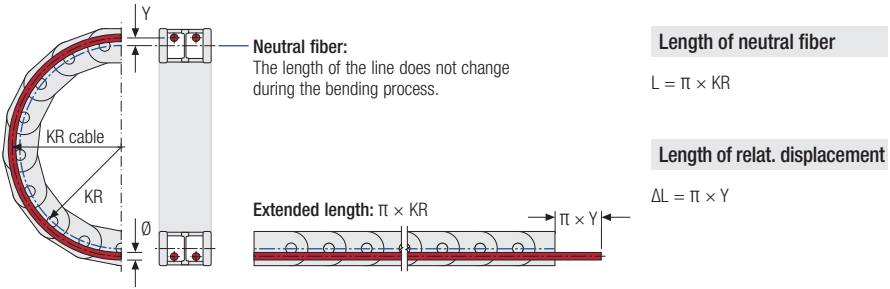

Due to the off-center placement, the cables move in the cable carrier by the value of the relative displacement. This can cause increased cable wear on the stays.

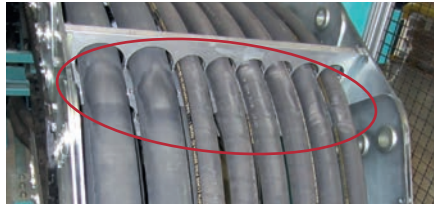

02 Placement guidelines for cables and hoses

Key for abbreviations on page 16

Design guidelines from page 64

Technical support: technik@kabelschlepp.de

Cable carriers are designed to protect moving energy lines and data lines which can be guided together in a variety of combinations. The following chapters list the guidelines which ensure configuration of the cable carrier system for maximum service life.

2.1 General guidelines

A "direction of view" is defined to allow a clear definition of the position of the cables in the cable carrier. For KABELSCHLEPP cable carriers, the view is always into the driver.

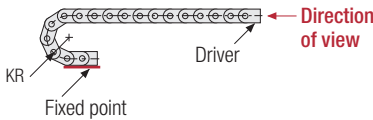

i Only cables which are suitable for use in cable carriers should be used, e.g. TRAXLINE® cables.

Cables and hoses have to be able to move freely in the cable carrier. They must not be attached or tied together.

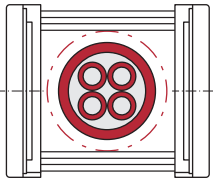

The following guide values apply for dimensioning the required clearance:

- **For round cables:**
10 % of the diameter*
- **For flat cables:**
10 % of the cable width/thickness each
- **For hoses:**
20 % of the diameter for pressure hoses**
10 % - 20 % for unpressured/low-pressure hoses*

* For diameter $d < 20$ mm, min. space requirement: $d + 2$ mm

** For diameter $d < 20$ mm, min. space requirement: $d + 4$ mm

Weight distribution for installation

For the installation of cables and hoses, please ensure that the cable weight is symmetrically distributed across the width of the cable carrier. Even loading can help the cable carrier to achieve its maximum service life.

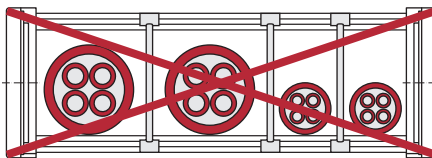

Poor weight distribution

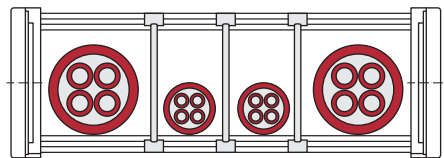

Good weight distribution

Configuration guidelines | Placement guidelines

No cable loops

When cutting the cables for installation in the cable carrier, remove the cable from the coil tangentially and not in loops.



Do not twist cables

When cutting the cables for installation in the cable carrier, unwind the cable from the drum without twisting it.

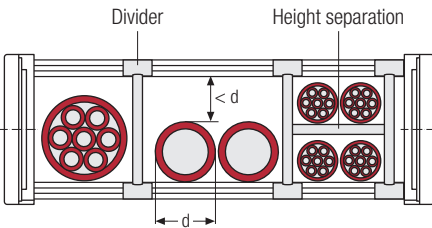

Separating multiple cables

Adjacent cables with strongly differing diameters should be separated by dividers. Directly adjacent placement of cables with strongly differing diameters has to be avoided. If this is unavoidable, ensure that the remaining clearance height is smaller than the smallest cable diameter. This is the only way to prevent the cables from becoming tangled.

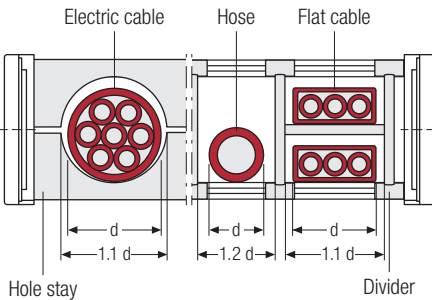

Multiple layers

When placing cables in multiple layers, we recommend installing a height separation between the individual layers for electric cables.

Individually manufactured hole stays or partitions through dividers prevent adjacent cables from rubbing against each other. In many cases, it is beneficial to place each cable in a separate chamber.

A height separation always has to be installed between multiple layers of flat cables.

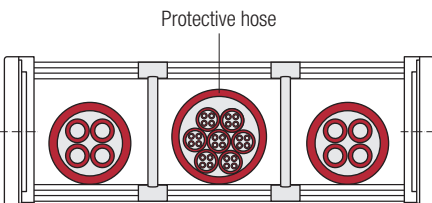

Collating in protective hoses

Thin hi-flex cables with low bending strength have to be loosely bundled and sorted in a protective hose. The cross section of the protective hose has to be significantly larger than the sum of the individual cable cross sections.

As a guideline for determining the cross section: each cable takes up approx. 10 % of its diameter as a clearance all around.

Configuration guidelines | Placement guidelines

Key for abbreviations on page 16

Design guidelines from page 64

Technical support: technik@kabelschlepp.de

online-engineer.de
Cable Carrier Configurator

It always has to be ensured that the cables can run through the bending radius KR without any tensions or force.

They have to move freely lengthwise and must not exert any towing forces on the cable carrier in the bend.

For multiple layer, the cables have to be placed in such a way that they also have enough clearance between them in the cable carrier bend.

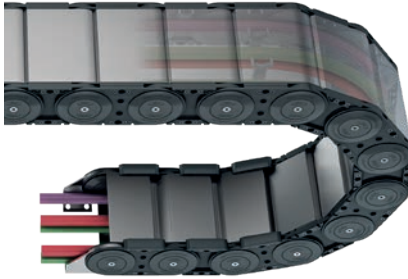
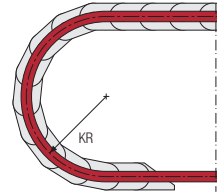

Installing cables and hoses in closed cable carriers

For large numbers of electric cables in covered cable carriers or in energy conduits, the current carrying capacity of the cables has to be configured according to the applicable standards, regulations and recommendations so that the maximum permissible temperatures for the corresponding cable materials and the cable carrier material are not exceeded.

For your configuration, please note that this is a closed system.

2.2 Placement of pressure hoses

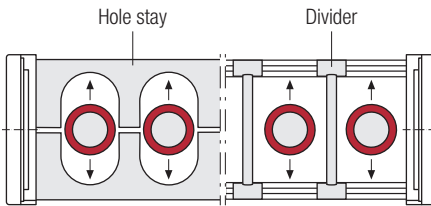

The following applies regardless of the partitioning type of the stay cross section:

Pressure hoses have to be able to move freely because they expand or contract during pressure changes!

Expansion or contraction can be compensated in the bending radius area. The required clearance can be calculated depending on the proportional change (manufacturer's information).

If technically possible, we recommend placing each pressure hose in a separate chamber.

Pressure hoses are often attached to a tube directly before the driver and fixed point connection. Length differences, which result from the pressure change but also from manufacturing tolerances during installation of the hoses, can result in increased wear in the area of the bending radius.

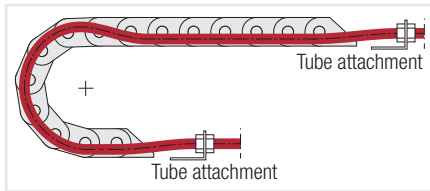

Hose too long

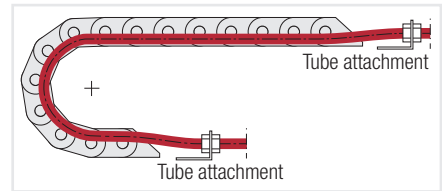

Hose too short

For your configuration, please take into account a suitable length compensation for the hoses so they can run through the bending radius without tensions or force. It is often sufficient to provide a loop before the fixed point to compensate for the hose length.

Configuration guidelines | Placement guidelines

2.3 Strain relief

The strain relief for the cables depends on cable type, length of the cable carrier and installation variant. Generally, it has to be ensured that the retention force is applied on the largest possible area of the outer jacket so that the cables are not crushed while also preventing displacement of the cables.

- Within the **unsupported area** of the cable carrier, electric cables should preferably be equipped with a strain relief on the driver and on the fixed point. For short travel lengths and smaller cable diameters, we recommend the use of strain relief combs and cable ties for this application. LineFix clamps can also be used for larger cable carriers which use a C-rail.
- **Longer travel lengths**, which require gliding operation of the cable carrier, should also be equipped with strain relief on the driver and on the fixed point. Secure strain relief, e.g. with LineFix clamps, has to be provided especially at the driver connection where push and pull forces are present. When using the strain relief at the fixed point of a gliding cable carrier, it primarily has to be ensured that the installed height of the strain relief is significantly smaller than the chain link height h_G in order to prevent a collision. For slow travel speeds, it is often sufficient to provide fixation with a strain relief comb and cable ties on the fixed point of gliding cable carriers.
- For vertically operating cable carriers, the cables also have to be provided with a strain relief on the driver and on the fixed point. For hanging cable carriers with very long travel lengths and high cable weights, it can be practical to install a double strain relief arrangement on both sides.
- Pressure hoses which will not be bolted on in direct proximity to the driver or fixed point also have to be provided with a strain relief, in the same way as the cables. We recommend the robust block clamps for this case.

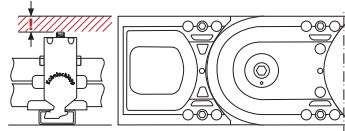

2.3.1 Strain relief for gliding cable carriers

Strain relief on the driver cable carrier end

After moving the cable carrier driver (moving cable carrier end) to the **pushing end position**, the cables are provided with a strain relief at the moving cable carrier end.

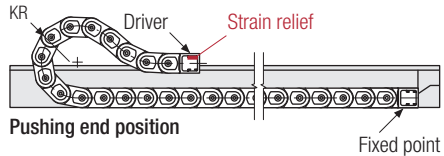

Correct cable length in the cable carrier

After moving the cable carrier driver (moving cable carrier end) to the **pulling end position** of the cable carrier, the cables are checked for tension-free length in the bend and, if necessary, "fed further into the cable carrier".

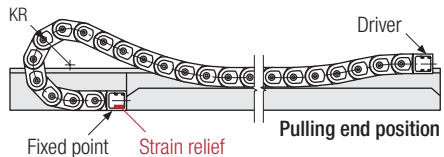

Strain relief on the fixed point cable carrier end

With this tension-free "inserted length", the cables are finally provided with a strain relief at the fixed point cable carrier end.



i Test operation of the cable carrier: After an initial test run, check the tension-free cable routing and, if necessary, adjust the strain relief at the fixed point.

03 Installation variants



Key for abbreviations on page 16

Design guidelines from page 64

Technical support: technik@kabelschlepp.de

online-engineer.de
Cable Carrier Configurator

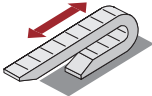
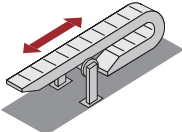
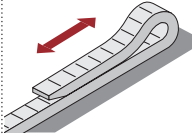
Overview of installation variants

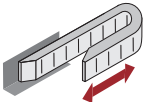
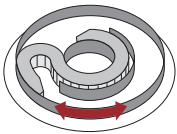
Code	Symbol	Designation	Plastic cable carriers	Plastic tubes	Steel cable carriers	Steel tubes	Page
INV 1		Horizontal arrangement, unsupported	•	•	•	•	80
INV 2		Horizontal arrangement, with support	◦ / –	◦ / –	•	•	81
INV 3		Horizontal arrangement, gliding in guide channel	•	•	•	•	82
INV 4		Vertical arrangement, hanging	•	•	•	•	83
INV 5		Vertical arrangement, standing	•	•	•	•	84
INV 6		Horizontal arrangement, rotated 90° (straight)	•	•	◦	◦	85
INV 7		Horizontal arrangement, rotated 90° (circular)	◦	–	◦	–	87

- Standard version
- Customized
- Not possible

Configuration guidelines | Installation variants

Code	Symbol	Designation	Plastic cable carriers	Plastic tubes	Steel cable carriers	Steel tubes	Page
INV 8		Horizontal arrangement, rotated 90° (rolled)	•	•	◦	◦	89
INV 9		Horizontal-vertical combined arrangement	•	•	•	•	89
INV 10		Unsupported arrangement, nested	•	•	•	•	89
INV 11		Zig-zag arrangement	◦	◦	◦	◦	90
INV 12		Vertical arrangement, hanging with support bolt	–	–	◦	◦ / –	90
INV 13		Horizontal arrangement, curled	•	•	◦	◦ / –	91
INV 14		Vertically rotating arrangement, hanging	◦	–	◦	–	91
INV 15		Roller chain	•	◦	–	–	91
INV 16		Arrangement with continuous support structure	◦	◦	◦	◦	92

INV 1

Horizontal arrangement, unsupported

Key for abbreviations on page 16

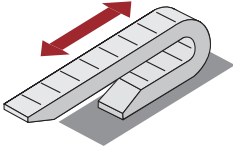

For unsupported arrangement, the driver connection of the cable carrier is attached to the movable system part and moves with it in the horizontal direction.

The upper run of the cable carrier is free, i.e. without support and without sag, parallel above the fully supported lower run.

The formulas and configuration information for this installation

variant can be found in the chapter "Determining the cable carrier length L_k for simple linear travel" on page 69.

Design guidelines from page 64

Special case

Horizontal arrangement, unsupported with overhang

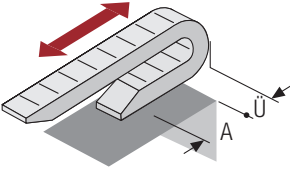

The lower run of the cable carrier is not supported across the entire length. We are happy to calculate the required dimensions $A + Ü$ for your individual application.

Please contact us for individual project planning for your specific application. We will be happy to help.

Rule of thumb

$$\dot{U}_{\max} \leq \frac{L_f}{4}$$

Technical support: technik@kabelschlepp.de



TSUBAKI KABELSCHLEPP technical support

If you have any questions about cable carriers or technical details please contact our technical support service at technik@kabelschlepp.de. We will be happy to help you.

INV 2

Horizontal arrangement with support

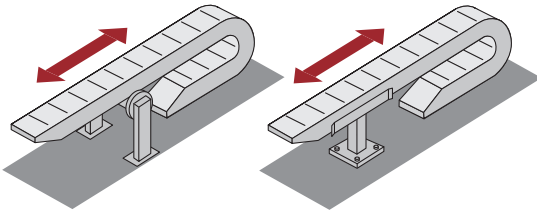

i If the unsupported length of the cable carrier is exceeded, the upper run can be supported.

We recommend using the next larger type instead of a cable carrier with support(s), if the installation situation allows this.

Support for the upper run is generally possible for almost all cable carriers. The support stand used for plastic cable carriers always has to be equipped with start-up levels. The upper run should be supported as far as possible.

Arrangement of the support

Due to the flexible material and the potential sag, however, there are limitations on the use of supports for plastic cable carriers. The following section therefore examines the arrangement of the support for **steel cable carriers with support rollers**:

Arrangement with one support roller:

for $L_S < 3 L_f$ $a_R = \frac{L_S}{6}$

The distance of the support from the fixed point is approx. 1/6 of the travel length!

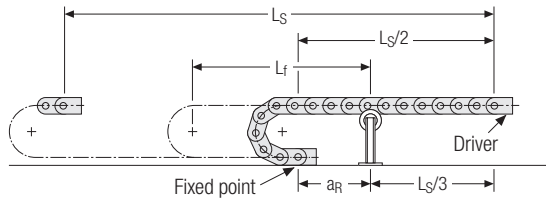

Arrangement with two support rollers:

for $L_S < 4 L_f$ $a_{R1} = 300 \text{ mm}$
 $a_{R2} = \frac{L_S}{4} - 150 \text{ mm}$

First support 300 mm behind the fixed point, second support at the center of the remaining unsupported length!

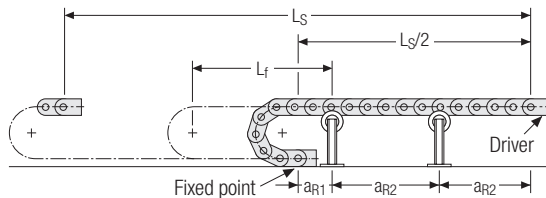

A travel speed of 1 m/s should not be exceeded. When using support rollers, the length L_f should only be 80 % of the value resulting from the load diagram, if possible.

Special version with lateral rollers:

for $L_S < 4 L_f$

To utilize the maximum possible travel length in an unsupported arrangement with stationary support structure.

The lateral track rollers are mounted on the chain links. An even running surface has to be ensured, with a support tray provided if necessary.

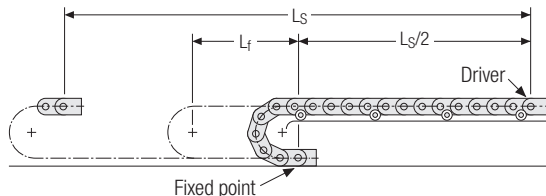

INV 3

Horizontal arrangement, gliding in the guide channel

Key for abbreviations on page 16

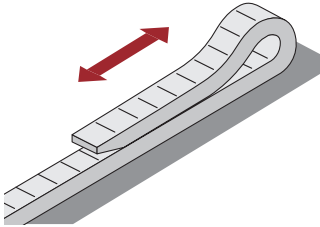

i The upper run of the cable carrier **glides** on the lower run or on a gliding surface of the associated guide channel.

Application: For long travel lengths which cannot be implemented as unsupported arrangements.

Condition: The cable carrier must be guided in a channel, though!

Design guidelines from page 64

Different cable carrier types provide the option of using glide shoes on the inner radius. These are manufactured from a special sliding and wear-resistant plastic. This allows the sliding friction factor to be reduced to a value of $\mu < 0.2$.

For steel cable carriers, the use of these elements is mandatory to prevent gliding of "steel on steel". The travel speed, however, should not exceed 1 m/s for gliding steel cable carriers. For steel cable carriers, the glide shoes are bolted onto the side band.

For plastic cable carriers, the glide shoes are simply clipped on the inner radius and can therefore easily be replaced if necessary.

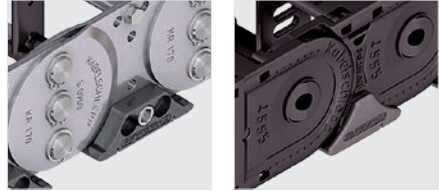

Technical support: technik@kabelschlepp.de

To reduce wear and increase the service life, we recommend using the abrasion resistant glide shoes for gliding applications. For travel speeds > 2.5 m/s, however, glide shoes should always be used.

Arrangement of the cable carrier

Single-sided arrangement with lowered driver connection and reverse bending radius (standard)

The cable carrier length is always calculated with the same formula as for the unsupported arrangement:

Cable carrier length L_k

$$L_k \approx \frac{L_s}{2} + L_B$$

Cable carrier length L_k rounded to pitch t

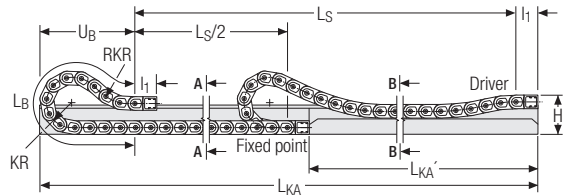

For the standard arrangement of the cable carrier, the driver connection is reduced for load reasons:

Connection height H

$$H = 3 h_G$$

The length of carrier in bend L_B is increased by the lower driver connection and the resulting cable carrier extension. To keep this elevation of the length of carrier in bend as small as possible, chain links with reverse bending radius (RKR) are used on the driver connection as a standard. This results in a slight S-shape for the bend in the thrust end position. The respective values for L_B can be found in the respective individual chapters for the cable carriers.

Configuration guidelines | Installation variants

For the configuration of this installation variant we recommend the simple way of determining the cable carrier length using our Configurator at online-engineer.de or requesting support from our support team.

Opposite arrangement with lowered driver connection and reverse bending radius

If the cable carrier is wider than the available space due to a very large number of cables, a second cable carrier can be used, running in the opposite direction. This almost halves the total width because the cables can be distributed among both cable carriers.

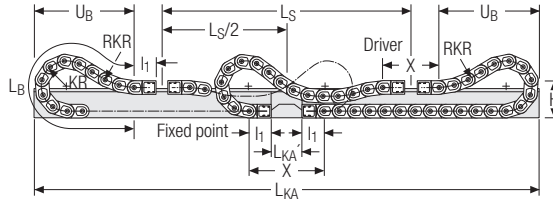

The cable carrier length is then determined in the same way as for single-sided arrangements. For only one moving consuming unit and a joint travel path, both cable carrier lengths have to be the same. As both cable carriers run in a guide channel, it must be ensured that they have the same outer width. More information and the details for dimensioning the guide channel can be found in chapter *Support trays and guide channels* on page 772.

INV 4 Vertical arrangement, hanging

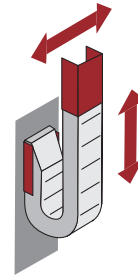
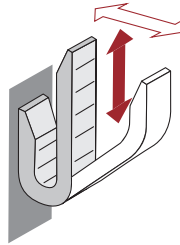

i **Direction of movement:**
only vertical

For a purely vertical movement process, the cable carrier can be mounted without special lateral support.

i **Direction of movement:**
vertical/horizontal combined

For a combined vertical/horizontal movement process, the cable carrier can be mounted without special lateral support.

i **Direction of movement:**
only vertical

If the entire system moves at a right angle to and/or alongside the hanging cable carrier, an additional lateral guide has to be mounted.

Please observe the guidelines for placement of cables in cable carriers from TSUBAKI KABELSCHLEPP, s. page 74.

It is practical to install the cable carrier **without or with only little pretension**.

As no direct load occurs in the hanging arrangement, pretension causes the cable carrier to bulge outwards from the pretension. In addition to the visual aspect, this significantly increases the installation dimensions.

The **cables have to be fixed** to the driver and fixed point in such a way that their weight and the resulting dynamic load are absorbed only by the strain relief. Determining the cable carrier length see page 69.

INV 5

Vertical arrangement, standing

Key for abbreviations on page 16

Design guidelines from page 64

Technical support: technik@kabelschlepp.de

online-engineer.de
Cable Carrier Configurator

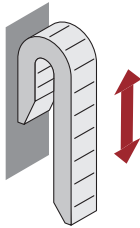

The cable carrier is mounted in such a way that parallel running of active run and passive run is ensured.

Determining the cable carrier length see page 69.

End connectors

The end connectors have to be mounted on the machine part (fixed point/driver) in such a way that the cable carrier cannot bend outwards, i.e. the connection must be **rigid**.

Connection height H

$$H = 2 KR + h_G$$

The distance between fixed point and driver connection corresponds to the selected bending radius.

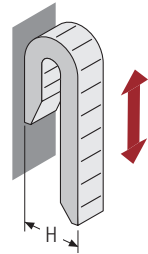

Support

The cable carrier generally has to be supported on the outside at the fixed point and at the driver.

The length of the support has to be defined depending on the additional load, the fill level, the travel length and the selected cable carrier.

Depending on the version of the support, the cable carriers are very often used with a slight pretension. If a short cable carrier does not require any support and if there is sufficient installation space, the standard pretension can be used. Use without pretension may result in the cable carrier bending. This is therefore not advisable.

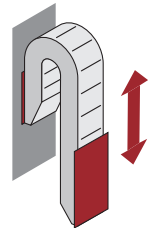

Direction of movement

Often, the complete unit additionally moves **at a right angle** to the vertical standing cable carrier. In this case, the cable carrier additionally has to be guided laterally.

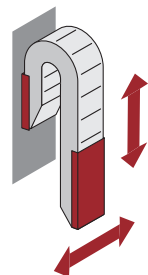

As a rule, only relatively short travel lengths can be implemented with the standing arrangement. If possible, the cable carrier should alternatively be used in a hanging arrangement. For this installation variant, the load on the overall system is significantly lower than with a standing arrangement.

Configuration guidelines | Installation variants

INV 6

Horizontal arrangement, rotated 90° (straight)

 The cable carrier used in normal horizontal direction is rotated by 90°, i.e. it glides on its outside or on special **slide discs** on a tray or in a channel. This arrangement can be implemented with almost all cable carrier types.

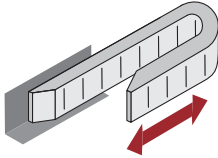

Application: Generally, cable carriers “rotated 90°” are used when the installation situation is primarily short on space with respect to height, preventing normal horizontal installation.

The installed cables have to be guided in the cross section of the cable carrier with **fixed separating elements** or in a **hole stay**, clearly separated from each other. This is the only way to prevent damage in the long run.

The technically best solution is the hole stay which provides the most secure guiding for the cables.

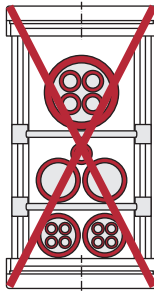

Frame stay with movable dividers

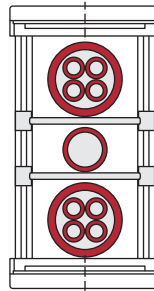

Frame stay with fixed dividers

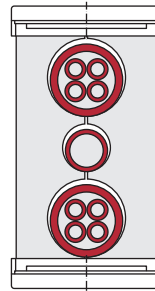

Best possible separation of cables in a hole stay

Systems for short travel lengths (with/without support)

The cable carriers can be used **unsupported** in the horizontal arrangement “rotated 90°” to a limited extent. The permitted unsupported length depends on the following parameters for this installation variant as well:

- additional load q_z
- bending radius KR
- connection option
- travel length L_S
- cable carrier width B_k

If the additional load and the unsupported length are too high, the cable carrier has to be supported on one side or overall.

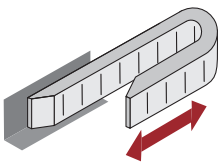

System without support

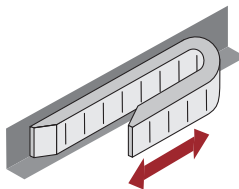

System with single-sided support

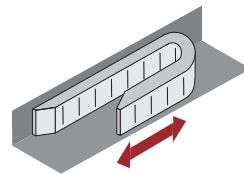

System with overall support

Configuration guidelines | Installation variants

Key for abbreviations on page 16

Design guidelines from page 64

Technical support: technik@kabelschlepp.de

online-engineer.de
Cable Carrier Configurator

System for long travel lengths (gliding in a guide channel)

Plastic cable carriers can be used for travel lengths far over 100 m with the arrangement "rotated 90° – straight". Over a period of more than 60 years, we have built multiple systems with the arrangement "single-sided" or "opposite" with or without special auxiliary fixtures.

Single-sided arrangement (with stepped guide channel)

b_{KA} = channel width of narrow section
 l_{KA} = length of narrowed channel

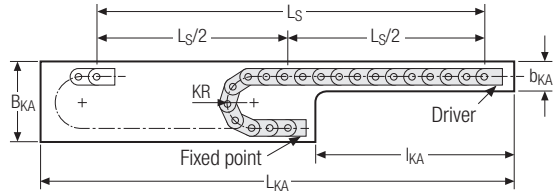

Opposite arrangement

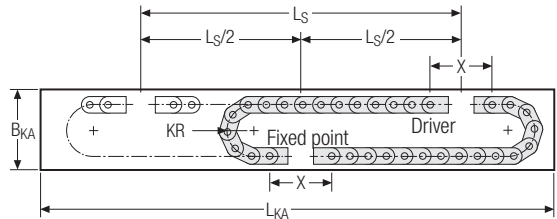

The cable carrier "rotated 90°" for long travel lengths **must** be guided in a channel. The material and texture of the channel base must be selected so they ensure low-wear travel with the lowest possible friction forces.

For long travel lengths, the cable carriers are used without pretension.

For **steel cable carriers**, corresponding gliding and guiding elements are mounted on the outside and/or inside of the side band, preventing grinding along the channel walls and ensuring smooth running of the system.

Support and guiding elements (combination examples):

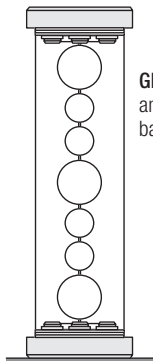

Gliders on upper and lower side band

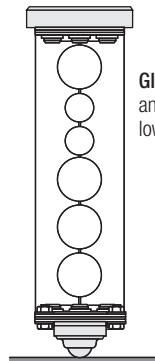

Gliders on the top and domes on the lower side band

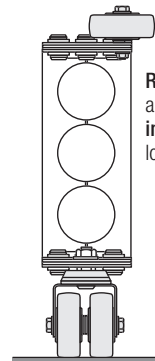

Rollers on the top and double steering rollers on the lower side band

INV 7

Horizontal arrangement, rotated 90° (circular)

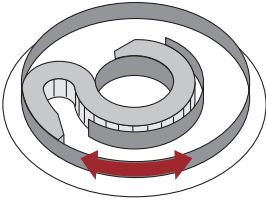

For this arrangement, the cable carrier rotated 90° is connected to machine parts which carry out a circular movement.

The combination of bending radius KR and reverse bending radius RKR causes the cable carrier to move in two circular directions in a targeted and defined manner.

The cable carrier system is connected to the inner and outer rings of a guide channel. The rotating ring (inside or outside) is the driver connection.

Application: Generally, cable carriers in this arrangement always have to be guided in a channel. The driver can be positioned inside or outside.

A special chain link design is required to allow the cable carrier to execute a circular movement.

The installed cables have to be guided in the cross section of the cable carrier with **fixed separating elements** or in a **hole stay**, clearly separated from each other. This is the only way to prevent damage in the long run.

The technically best solution is the hole stay which provides the most secure guiding for the cables.

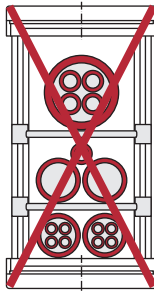

Frame stay with movable dividers

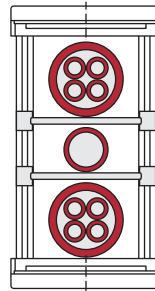

Frame stay with fixed dividers

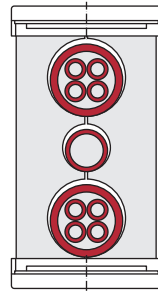

Best possible separation of cables in a hole stay

Due to the strong relative displacement and the continuously changing radius ratios, cables should only be installed in one layer to ensure maximum service life.

For **steel cable carriers**, corresponding gliding and guiding elements are mounted on the outside and/or inside of the side band, preventing grinding along the channel walls and ensuring smooth running of the system (see page 86).



TSUBAKI KABELSCHLEPP technical support

If you have any questions about cable carriers or technical details please contact our technical support service at technik@kabelschlepp.de. We will be happy to help you.

Configuration guidelines | Installation variants

Single-sided arrangement

with offset guide channel (schematic diagram)

The cable carrier system shown here has the driver on the inner radius. There are also frequent applications where the driver has to be positioned on the outer radius.

To ensure sufficient guiding of the cable carrier in this case, moving guide plates are required for larger angles of rotation. As this version is more complex, the "inside rotating circular arrangement" should be preferred.

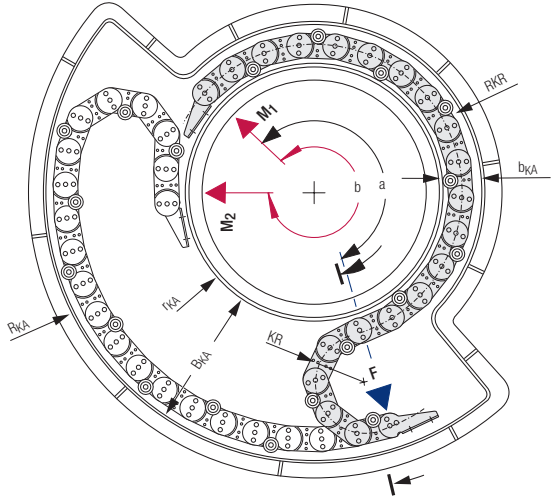

Opposite arrangement with guide carriage (schematic diagram)

For opposite arrangements, a moving support fixture or a guide carriage has to be positioned in the channel due to the combination of KR and RKR.

Coupling of multiple circular systems is possible for angles of rotation over 500°.

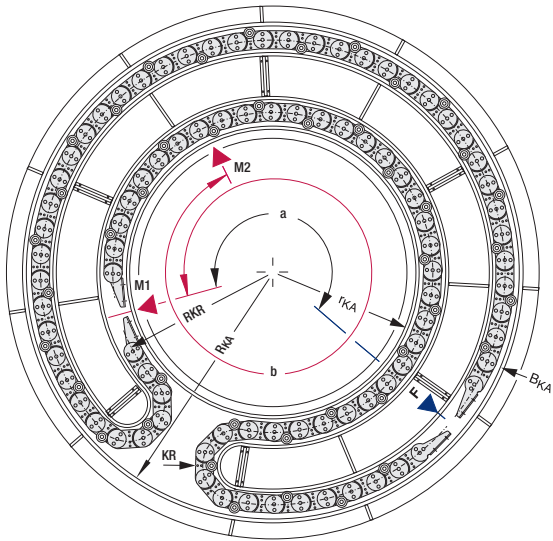

Abbreviated symbols:

- α = fixed point angle
- β = travel length
- B_E = width of cable carrier
- b_{KA} = channel width of narrow section
- B_{KA} = channel width
- H_E = height of cable carrier
- H_{KA} = height of the guide channel
- r_{KA} = channel radius – inside
- R_{KA} = channel radius – outside
- F = fixed point
- M 1 = driver end position 1
- M 2 = driver end position 2

Due to the variety of configuration options for this installation variant, we recommend contacting our technical support. We require the following parameters for preparing a solution:

- inner diameter
- outer diameter
- travel length (angle of rotation)
- single-sided or opposite arrangement?
- driver on inner or outer radius? (inner radius preferred for single-sided arrangement)
- restrictions for the installation space? (e.g. installation height)
- cable list
- environmental conditions (e.g. chips, dirt)

Configuration guidelines | Installation variants

INV 8

Horizontal arrangement, rotated 90° (rolled)

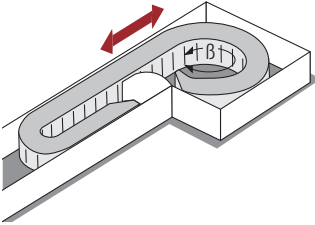

i For this arrangement, the cable carrier rotated 90° is connected to a consuming unit which carries out a circular movement. The travel length “β” is indicated in degrees!

Application: The application is designed for circular movements which are wound on a rotating body. This type of cable carrier is preferred for smaller systems, usually with large movement angles.

A standard cable carrier is used. A reverse bending radius is not required. The winding of the carrier limits the angle of rotation to approx. $\beta = 270^\circ$. For the implementation of larger angles of rotation, additional guide plates are required to prevent a collision on the driver. This application is practically a combination of installation variants 6 and 7. Accordingly, similar configuration criteria are used.

INV 9

Horizontal-vertical combined arrangement

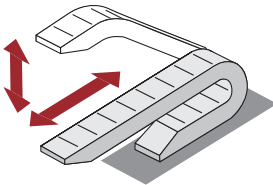

i Our cable carriers can also be used for combined horizontal/vertical movements.

This arrangement requires no special technical preconditions, but calculation of the cable carrier length is more complex and should be carried out by our technical support.

INV 10

Unsupported arrangement, nested

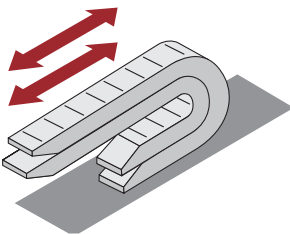

i This arrangement is possible for all cable carriers. If the available space do not permit installation of a cable carrier due to the required width, the system can be configured in a **nested** arrangement.

For smooth running, it has to be ensured that both cable carriers can move freely. This means sufficient distance between the upper run (min. 20 mm, depending on cable carrier type) and the carrier bends (min. half of chain link height).

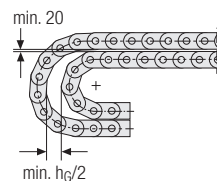

For long steel cable carriers there is an option for positioning guide plates at the side band of the outer carrier to ensure alignment of the inner carrier.

INV 11 Zig-zag arrangement

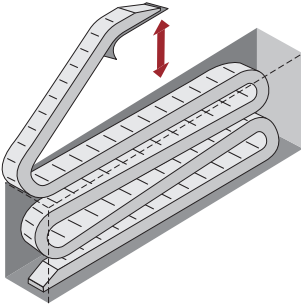

For some areas of application (e.g. stage and storage systems), it is often not possible to use a vertical hanging or standing cable carrier due to space restrictions. The so-called zig-zag arrangement is used in these cases.

As several bends fold on top of one another, the cable carrier has to be guided in all directions and therefore settles into a type of basket or sheet steel housing.

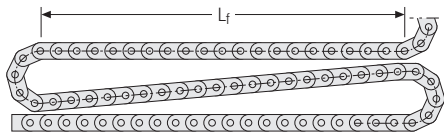

The following parameters are required for dimensioning the system:

- travel length
- travel speed
- cables installed
- minimum bending radius of guided cables
- maximum permitted height
- maximum permitted basket dimensions (length, width)

When dimensioning the basket length, ensure that the unsupported length L_f of the selected cable carrier is not exceeded. Depending on the length and weight of the cable carrier, supporting the bend on the driver with a bent plate is a measure which has a positive effect on the service life.

INV 12 Vertical arrangement, hanging with support bolt

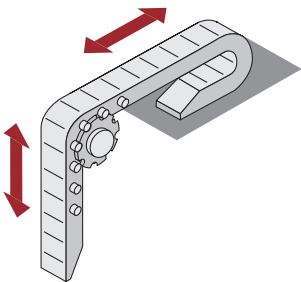

The vertical arrangement of the cable carrier with additional support elements offers the option of using the cable carrier as a lifting element for the attached system parts (e.g. operating panels, manipulators).

The cable carrier is driven via chain wheels. The pitch circle diameter has to be equal to or greater than the selected bending radius of the cable carrier. The drive is motorized or via a counterweight.

Due to the great number of configuration aspects, we would ask you to contact our technical support.

INV 13

Horizontal arrangement, curled

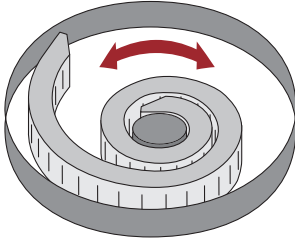

i In some cases, a large angle of rotation cannot be implemented with one of the usual applications for circular movements. In these cases, an examination with regard to the options for curling up the cable carrier is recommended.

A standard cable carrier can be used, but a relatively large installation space is required for curling up the configuration.

The rotation in this application is limited by a maximum double wrapping of the inner diameter. Multiple wrappings cause the cable carrier to jam.

INV 14

Vertically rotating arrangement, hanging

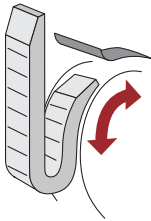

i This installation variant is often used for swiveled drums and turning devices.

The part rotating around the diameter requires chain links with KR and RKR in this area.

If the angle of rotation is over 180° (depending on the arrangement), an additional guide plate is required on the outer radius to prevent the cable carrier from tipping over.

INV 15

Roller chain

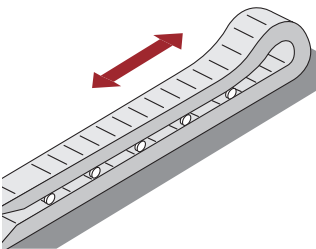

i Roller chains are primarily used where very long travel lengths lead to very high push and pull forces and gliding cable carriers reach their limits. The most effective installation variant is the RSC (rail supported carrier) system. This is a cable carrier where the design in combination with an optimized guide channel ensures 100 % roller operation over the entire travel length. This results in minimum mechanical load and a low noise level.

This makes the system suitable not only for extremely long travel lengths, but also for travel speeds over 5 m/s.

Despite the roller design, the RSC system can be fully wound on a reel and is therefore ideal for complete solutions with inserted cables for long travel lengths.

Dimensioning is similarly easy as for a gliding cable carrier. For effective and fast implementation, especially for large projects, we can offer our expert help.

INV 16

Arrangement with continuous support structure

Key for abbreviations on page 16

Design guidelines from page 64

Technical support: technik@kabelschlepp.de

online-engineer.de
Cable Carrier Configurator

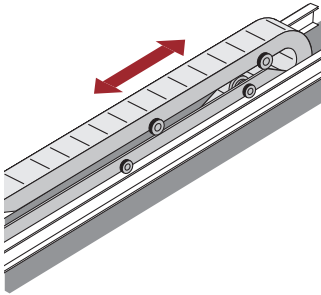

While this installation variant is also possible for plastic cable carriers, it is primarily used for steel cable carriers.

If the technical conditions no longer permit the use of a gliding cable carrier or a cable carrier with support rollers with regard to travel length, acceleration or speed, a so-called cable carrier unit with a continuous moving support structure can be used.

Cable carrier units are particularly suitable for use with large travel lengths and high travel speeds under rough operating conditions and heavy loads. There is a variety of different versions of this installation variant. As an example, we present the most used type 225 here.

Due to the complexity, this type of cable carrier system should be dimensioned in cooperation with our engineers.

Cable carrier installation type 225

The cable carrier installation is either configured as a single-sided system with one cable carrier installation or as an opposite arrangement with two cable carriers.

A carriage guided on rollers in a running frame supports the cable carriers along their entire length. The support structure is moved in both directions with a cable pull system which is attached to the rolling carriage system. Due to the roller support and roller guiding of the cable carriers

on the support carriage and of the support carriage on the running frame, only minimal friction forces are generated in the system. Systems with the following limit values have been supplied so far:

- longest travel length: $L_{S \max.} = 222 \text{ m}$
- highest travel speed: $v_{\max} = 4 \text{ m/s}$
- greatest travel acceleration: $a_{\max} = 8 \text{ m/s}^2$

Single-sided arrangement

(schematic diagram)

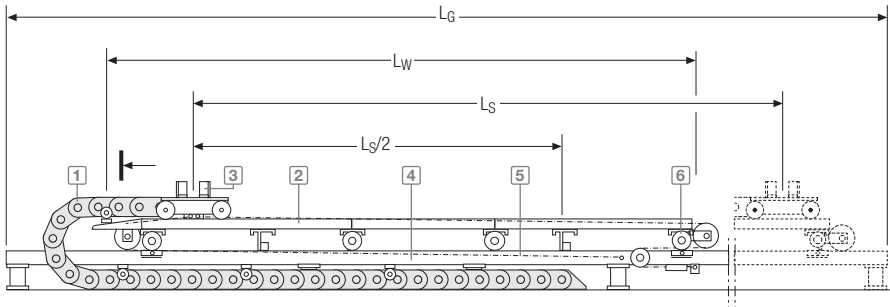

Opposite arrangement (schematic diagram)

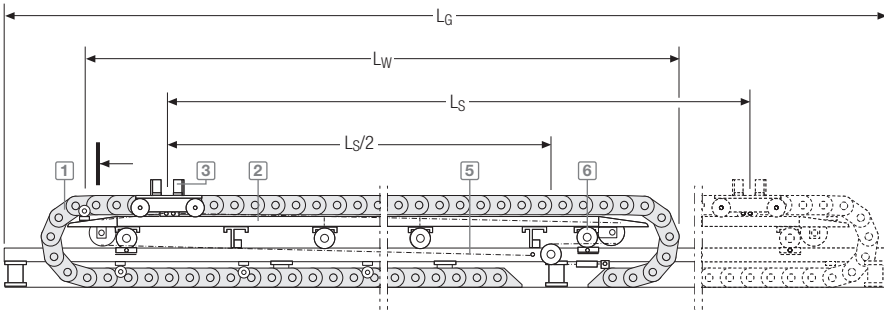

Cross section of the cable carrier installation

Abbreviated symbols:

- B_D = clear width in the running frame
- B_G = running frame width
- B_K = cable carrier width
- B_W = support carriage width (max. width)
- H = installation height of the cable carrier(s)
- H_G = running frame height
- L_G = running frame length
- L_S = travel length
- L_W = support carriage length

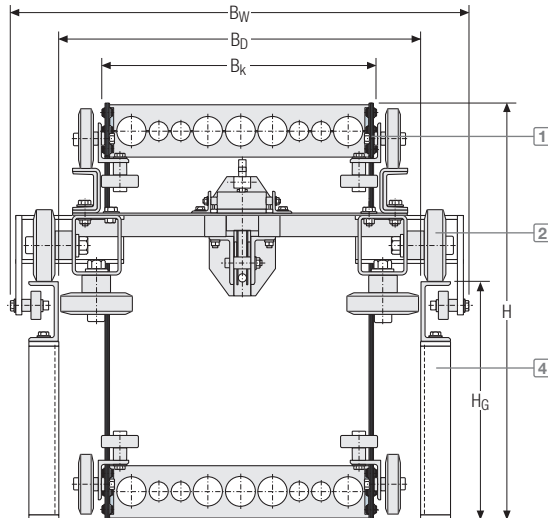

The cable carrier installation type 225 consists of the following assemblies:

- 1 Cable carrier(s)**
with laterally attached track rollers and guide rollers
- 2 Support carriage** with track rollers and guide rollers supporting across the entire length
- 3 Rolling carriage system** with track rollers and guide rollers
- 4 Running frame**
- 5 Steel cable**
- 6 Cable tensioning roller**
- 7 Tensioning device**

Materials information

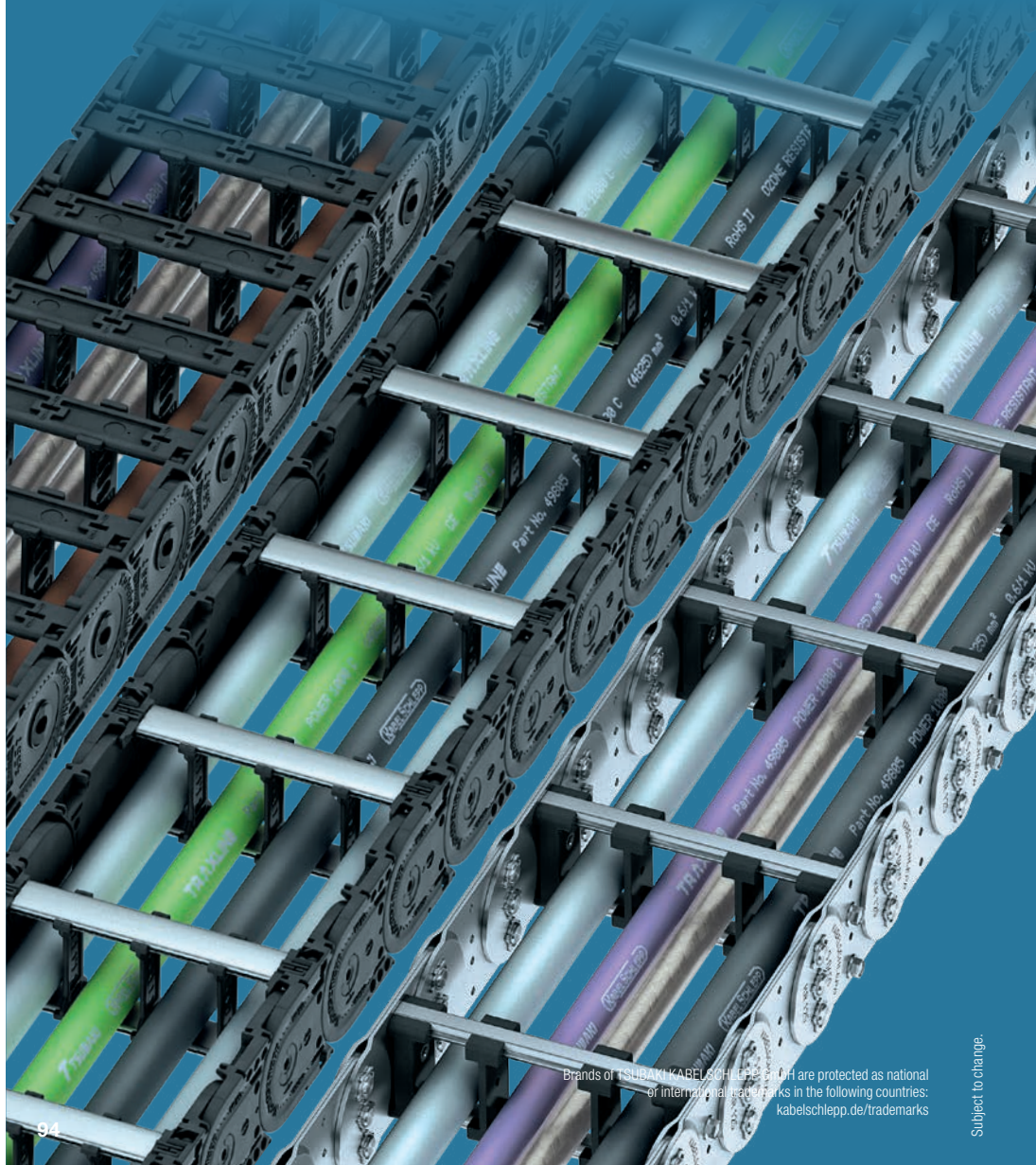

Brands of TSUBAKI KABELSCHLEPP GmbH are protected as national or international trademarks in the following countries: kabelschlepp.de/trademarks

Subject to change.

Content

01

Plastics page 96

- Standard materials
- Special materials
- Material code
- Colors
- Chemical resistance
- Environmental conditions

02

Metals page 101

- Steel and aluminum properties
- Area of application according to product series

03

Application temperatures page 102

- Application temperatures according to material

04

Tribology page 103

- Cost savings from low jacket abrasion

05

ATEX/ESD page 104

- Protection against explosions
- Conductive ESD cable carriers

Material selection

The composition of different materials allows customers to select the individual cable carrier for their application.

The selection of the right material is often linked to the following parameters:

- Friction values
- Friction partners
- Ambient temperature
- Robustness
- Optics
- Noise emission
- Contamination
- Humidity

Key for abbreviations
on page 16

Design guidelines
from page 64

Technical support:
technik@kabelschlepp.de

online-engineer.de
Cable Carrier Configurator

01 Plastics

1.1 Standard materials

The standard plastic used for most of our product is a PA6 GF35.

This material has the best price-performance ratio, confirmed by countless internal tests and by our customers, to meet the requirements for modern cable carriers.



The use for standard products is structured as follows (information refers to the side bands and other components, see p. 95):

Series	Plastic for main components	Series	Plastic for main components
BASIC-LINE		VARIO-LINE	
MONO series	PA6 GF35	M series	PA6 GF35
QuickTrax® series	PA6 GF35 + PA6	XL series	PA6 GF35
UNIFLEX Advanced series	PA6 GF35	QUANTUM® series	PP
TKP35 series	PA6 GF30	TKR series	PA66
TKK series	PA6 GF35	PLASTIC-TUBES	
BASIC-LINE PLUS		TKA series	PA6 GF35
EasyTrax® series	PA6 GF35 + PA6	MT series	PA6 GF35
PROTUM® series	PA6 + TPE	XLT series	PA6 GF35
VARIO-LINE		3D-LINE	
K series	PA6 GF35	ROBOTRAX® system	POM
Master series	PA6 GF35		

1.2 Special materials

Special materials are modified plastics which are suitable for applications outside the standard. There are different variants for a variety of different requirements. The following table can help with the selection of the correct material for the application at hand. It has to be noted that not all materials can be used in all products. Please contact us.

Plastic type	Property	Code
PA6 GF35	Standard material for common applications Performance range according to material data sheet	7422 7370
PA6.6 GF	Special material for ATEX application following ATEX Directive 2014/34/EU	7400
PA6.6	Standard material for UMB	7408
POM	Standard material for ROBOTRAX®	7412
PA6 GF30	Impact-strength-modified special material for use in cold environments	7488
PA46 GF30	Modified special material for use in hot temperature areas	7341
PA66 GF25	Modified special material with special requirements for fire behavior (VO)	7414
PA66 CF	Modified special material with conducting properties for voltage (ESD)	7366
PA6 GF 35 cross-linked	Special material for absorbing contact temperatures up to 850 °C (cross-linking)	Indicate cross-linking when ordering.

1.3 Material code

Codes are assigned to each plastic to differentiate between the different plastic materials. The code has four digits and can be identified as a simplified code on most plastic components. This is embossed into the component on a material dial at the side of the chain links of the cable carrier.

Code	Coding	Material
7422	AD	PA6 GF35



Example of material dial























TSUBAKI KABELSCHLEPP technical support

If you have any questions about materials or technical details, please contact our technical support service at technik@kabelschlepp.de. We will be happy to help you.

1.4 Colors

The price is always based on the colour black. In addition, there are other individual colours in our assortment, which are manufactured article-related and belong to the standard. For all other colours additional costs, minimum quantities and delivery times have to be considered.

Colours which are not included in the table are, if technically possible, individually calculated according to article and quantity. All technical values regarding stability and material properties apply only to black versions. Coloured cable carriers and articles made of special material have changed properties and are not always available in all colours for technical reasons.

	RAL-Farbbezeichnung	Code	ähnlich RAL-Nr.	Grundmaterial
	Sulfur yellow	7380	1016	7423
	Signal red	7342	3001	7423
	Ruby red	7384	3003	7423
	Traffic blue	7373	5013	7423
	Sky blue	7494	5015	7423
	Night blue	7344	5022	7423
	Turquoise green	7343	6016	7423
	Squirrel gray	7377	7000	7423
	Iron grey	7339	7011	7423
	Light Grey	7378	7035	7423
	Agate grey	7372	7038	7423
	Window gray	7497	7040	7423
	Traffic grey A	7367	7042	7423
	Traffic grey A	7495	7042	7423
	Tele grey 1	7354	7045	7423
	Signal white	7371	9003	7423
	Jet black	7336	9005	7423
	White aluminum	7397	9006	7423
	Pure White	7353	9010	7423
	Traffic White	7486	9016	7423





Key for abbreviations
on page 16Design guidelines
from page 64Technical support:
technik@kabelschlepp.de

1.5 Chemical resistance of the standard material KS 7422

This resistance table shows that the use of plastic cable carriers is not recommended for any acidic media.

In these cases, we recommend using our proven stainless steel cable carriers!















































Abbreviated symbols:

-  resistant
-  limited resistance
-  not resistant
-  soluble

GL = saturated aqueous solution

H = standard commercial grade

TR = technically pure

Medium	Mass percentage	Temperature in °C	Resistance
Acetone	TR		
Formic acid	10		
Ammonia (liquid)	TR		
Ammonia		+ 20	
Petrol	H	+ 85	
Benzene	H		
Bitumen	H		
Boric acid (aqueous)	H		
Butyric acid (aqueous)	20		
Calcium chloride (aqueous)	GL	+ 23	
Chlorine, hydrocarbon			
Chlorine, chlorinated water	H		
Chromic acid (aqueous)	10		
Diesel oil	H		
Acetic acid (aqueous conc.)	95		
Acetic acid (aqueous)	10		
Ethanol	40		
Ethyl acetate	TR		
Paint and varnish			
Grease and wax	H		
Liquid gas (DIN 51622)			
Hydrofluorocarbons			
Formaldehyde and polymac.	TR		
Formaldehyde (aqueous)	30		
Hydraulic oil	H		
Potash lye	10		
Potassium chloride (aqueous)	10		
Potassium nitrate (aqueous)	10		
Methyl acetate	TR		
Milk	H		
Lactic acid (aqueous)	10		
Lactic acid	90		
Mineral oil	H		
Sodium carbonate (aqueous)	10		
Oil/cooking oil, lubricating oil	H		
Oleic acid	H		
Paraffin, paraffin oil	H		
Polyester resin	H		
Propane, propene	TR		
Mercury	TR		
Hydrochloric acid (aqueous)	> 20		
Hydrochloric acid	2		
Lubricant, cooking grease	H		
Vaseline	H		
Tartartic acid (aqueous)	10		
Tartartic acid	50		
Xylene	TR		
Sulfuric acid	98		

More information on request.

Please contact us!

1.6 Ambient conditions for standard materials

Key for abbreviations
on page 16



Weather

The plastic used by TSUBAKI KABELSCHLEPP is ideal for outdoor use. The mechanical properties of the cable carriers are not affected.

7422 is UV resistant!



Radiation resistance

Depending on the intensity, plastic cable carriers can also be used conditionally under the influence of radioactive radiation. If possible, we recommend the use of steel cable carriers.

Please consult us in any case!



Burning behavior

The plastic used by TSUBAKI KABELSCHLEPP was tested as per UL 94.

More information on request. **Please contact us!**

Design guidelines
from page 64

1.7 Ambient conditions for special purpose materials



High-temperature resistance

Our special purpose material 7341 is high-temperature resistant and therefore ideal for use in high-temperature areas. Please contact us, as not all special purpose materials are available for all cable carrier types and temperature ranges.

More information on request. **Please contact us!**

Thermal properties	Permissible temperature range
Continuous ambient temperature	+ 20 to +150 °C
Up to max. 5000 hours	up to +185 °C
Short-term	up to +285 °C

Technical support:
technik@kabelschlepp.de



Cold store resistance

Our special purpose material 7488 is low-temperature resistant and therefore ideal for use in cold stores and extremely low temperatures.

More information on request. **Please contact us!**

Thermal properties	Permissible temperature range
Continuous ambient temperature	-50 to +40 °C

online-engineer.de
Cable Carrier Configurator

These cable carriers can only be manufactured in the color yellowish/white (transparent).

02 Metals

2.1 Steel and aluminum properties

Type	Use	Code
Steel		
Galvanized steel	All applications which do not require any special corrosion protection, especially for general machinery and plants, as well as in areas of application where plastic cable carriers are not permitted due to their load capacity, strain, elasticity and ambient conditions (link plates, channel parts, connecting elements, connections, etc.)	St vz
Hardened steel, black coated		Sb
Stainless steel similar to 1.4301; AISI304	Same areas of application as galvanized steel, but with special requirements for corrosion resistance (link plates, channel parts, connecting elements, connections)	ER1
Stainless steel similar to 1.4571; 1.4404; AISI316Ti; AISI316L	Same areas of application such as galvanized steel, but with special suitability for ambient conditions with salt concentration, e.g.: ports, food compatibility (link plates, channel parts, connecting elements, connections)	ER 1S
Stainless steel similar to 1.4462; 318LN	High strength for applications in the chemical and petrochemical industry, offshore, textile industry, cellulose production, dyeworks, paint industry, synthetic resin industry, rubber industry, shipbuilding	ER 2
Light alloy		
Aluminum alloy	Perfect gliding partner for cables and hoses, very good cold resistance and salt-water resistance (stays, hole stays, height separations)	Al

2.2 Area of application according to product series

Some products and product groups consist of a variety of different materials. The use for the metals is structured as follows (information refers to the side bands and other components):

Series	Main metal components
STEEL-LINE	
LS series	Sb
LSX series	ER1
S series	St vz
SX series	ER1, ER1S, ER2
Metal stays, covers	Al

03 Application temperatures

Our materials have different application temperatures. The following table shows the application temperatures for the most frequently used materials.

Material	Upper continuous application temperature	Lower continuous application temperature
PA6 GF35	+ 100 °C	- 30 °C
Galvanized steel	+ 210 °C	- 40 °C
ER1	+ 500 °C	- 80 °C
ER1S	+ 550 °C	- 80 °C
ER2	+ 250 °C	- 100 °C
Aluminum	+ 140 °C	- 80 °C



TSUBAKI KABELSCHLEPP technical support

If you have any questions about cable carriers or technical details, please contact our technical support at technik@kabelschlepp.de. We will be happy to help you.

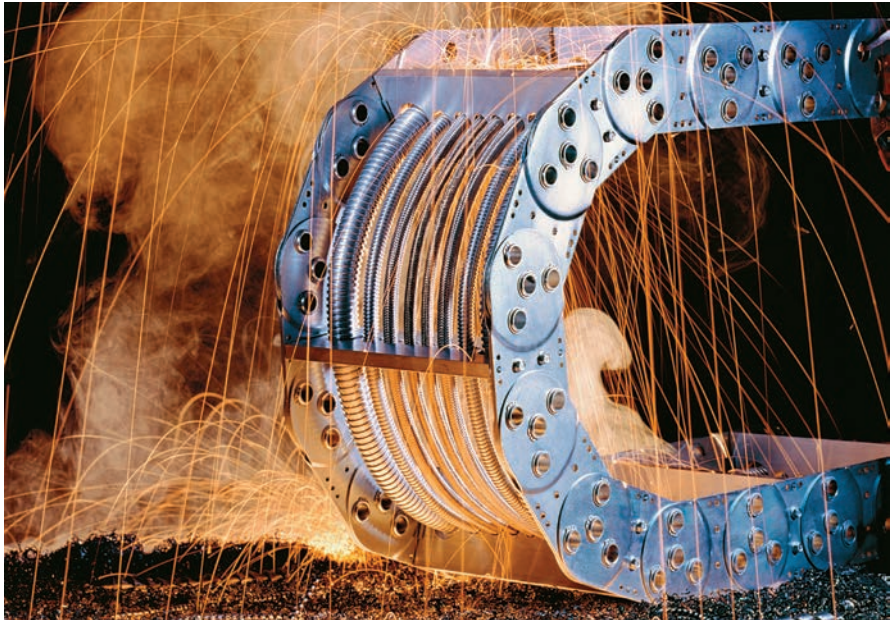

04 Tribology

Low jacket abrasion is an essential prerequisite for a long service life of the cables in a cable carrier. In addition to the jacket material, the stay material as the support surface for the cables affects jacket abrasion. We have analyzed the abrasion on different cables with different stay materials in extensive tests.

Aluminum stays proved to be a gentle support for the cable jackets. This result does not depend on the cable manufacturer and applies to all jacket materials tested. Jacket abrasion is of minor importance for many standard applications. Simple solid plastic cable carriers from BASIC-LINE and BASIC-LINE *Plus* can be used without problems in these cases.

For more challenging applications with large relative movements between stay and cable, the outer cable jacket is subject to a high level of wear through abrasion. In these cases, we recommend using cable carriers with aluminum stays to increase the service life of the cables.

Save costs through lower jacket abrasion on cables

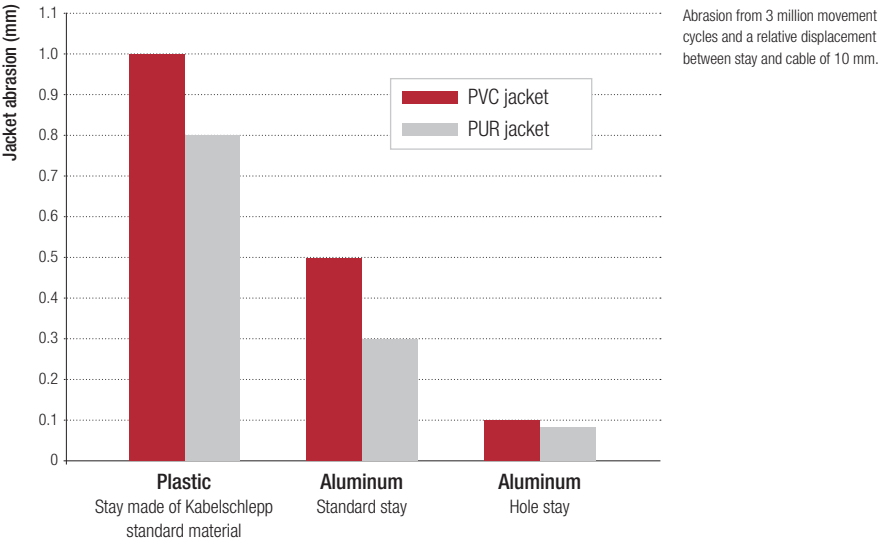

In addition to reducing abrasion, aluminum is ideal as a stay material due to its high strength and low intrinsic weight. Cable carrier widths up to 1000 mm can be achieved without putting special strain on the cable carrier through additional weight.



05 ATEX / ESD

Key for abbreviations
on page 16Design guidelines
from page 64Technical support:
technik@kabelschlepp.de

5.1 Protection against explosions

The Atex 2014/34/EU is the applicable EU explosion protection directive which must be fulfilled by devices and protection systems for use in explosive atmospheres. This also requires the prevention of explosive electrostatic discharge (ESD).

One method for preventing explosive ESD is a sufficiently low surface resistance of the affected component. Low surface resistance of a material acts like an electric short circuit and leads to a charge compensation of charged surfaces. This means that no explosion can be triggered in an explosive atmosphere.

Our special material 7400 was tested and certified by the National Metrology Institute of Germany (PTB) in Braunschweig. The surface resistance of less than $10^6 \Omega$ is clearly below the maximum limit value of $10^9 \Omega$ required in applicable regulations. This means that this material can be used for all devices and protection systems in explosive atmospheres without limitations.

Please contact us if you require KABELSCHLEPP cable carriers for use in explosive atmospheres. In addition to competent advice, we can provide you with all documentation required by the ATEX Directive, such as Declaration of Conformity, operating instructions, etc.



Our explosion-protected cable carriers can be used for all devices which are covered by the ATEX Directive 2014/34/EU.

5.2 Conductive ESD cable carriers

Electrostatic discharge (ESD) is a hazard when manufacturing and processing electronic components. If no adequate protection is provided, damage can occur. The requirements for materials, tools and therefore also cable carriers are defined in the ESD standard DIN EN 61340.

Our proven ESD cable carriers, which are made of our special material 7366, meet the requirements of the ESD standards with regard to conductance and resistance behavior.

Increasing miniaturization for semiconductor components leads to greater ESD sensitivity and therefore requires better ESD protection.

This requires a lower surface resistance of the plastic cable carriers used for handling and assembly.



Our ESD cable carriers meet the requirements of the ESD standards DIN EN 61340-5-1 and DIN EN 61340-5-2.

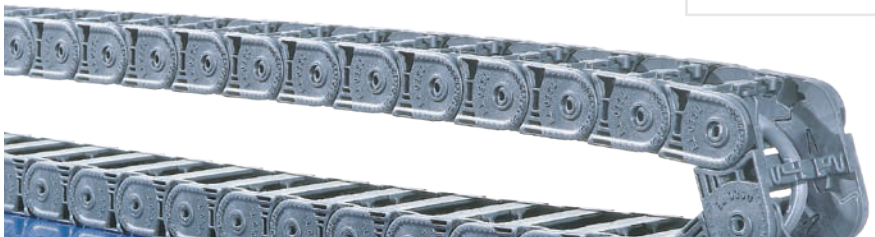

Low surface resistance through nanotubes

Our ESD material is modified through nano technology and equipped with carbon nanotubes, among other things.

Carbon nanotubes are used as a functional filler. Due to their graphitic surface structure they have a high electric conductance. Cable carriers made from this material have a surface resistance of $\leq 10^5 \Omega$ which far exceeds the values required by the ESD standard.

Carbon nanotubes have a diameter of only a few nanometers and a length of up to a few millimeters.

Cable carriers with nanotubes

- Low surface resistance: $\leq 10^5 \Omega$
- Significantly exceed the values required by the ESD standard
- Areas of application: chip handling, semiconductor manufacturing, electronics manufacturing, solar technology

Higher conductance of the complete cable carrier

The large specific surface and the extremely even distribution of the nanotubes in the material achieves good conductance even at the contact points between the chain links and therefore across the entire cable carrier length. A resistance of $\leq 10^5 \Omega$ was measured on a KABELSCHLEPP cable carrier of type ET 0320.025.030.038 with a length of 125 links (= 4 m).

Quality with factory certificate

Each ESD cable carrier with nanotubes technology is supplied with a KABELSCHLEPP factory certificate to certify its quality.



High stability

The modification of the fiberglass-reinforced material with nanotubes makes the cable carriers even sturdier.

The nanotubes have a sixth of the weight of steel but their tensile strength is multiple times higher.

This also increases the mechanical properties while retaining the high elasticity of the cable carriers made of ESD material. This effect is also applied successfully in numerous sports equipment, e.g. tennis rackets, bicycles and golf clubs.

High conductance even after one hundred thousand movement cycles

The test shows that the surface resistance of the complete cable carrier decreases during the running-in phase and then remains constant at 10Ω .

Surface resistance ET 0320.030.028-544 with ESD material

